

PLUS

Copyboard M-18S/M-18W

User's Manual

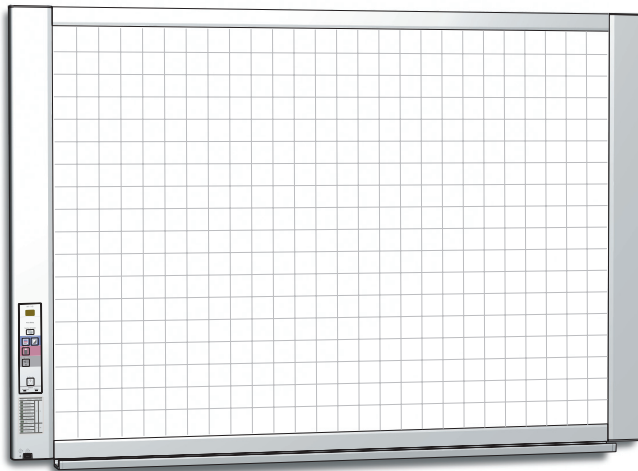

Thank you for your purchase of the PLUS Copyboard.
Please read this User's Manual carefully before use to take full advantage of the functions of this product. After you have finished reading the manual, please keep it for future reference.

Introduction

This manual is for both the M-18S and M-18W models.

The copyboards come in two sizes: standard size (model M-18S) and wide size (model M-18W).

The descriptions and diagrams in this manual refer to the model M-18S.

* When functions or operations are specific to a certain model of copyboard, the model name is specified.

Trademarks

- Microsoft and Windows are registered trademarks or trademarks in the United States and other countries of the Microsoft Corporation.
- Adobe, Adobe Acrobat Reader and Adobe Flash are trademarks of Adobe Systems Incorporated.
- Velcro is a registered trademark of Velcro Industries.

The trademarks of the various companies and the product trademarks, even when not written down, will be given due respect.

Product names and company names appearing in this manual are registered trademarks or trademarks of the respective companies.

- (1) The contents of this manual may not be reprinted in part or whole without permission.
- (2) The contents of this manual are subject to change without notice.
- (3) Great care has been taken in the creation of this manual; however, should any questionable points, errors, or omissions be apparent, please contact us.
- (4) Notwithstanding Section (3), this company will not be responsible for any claims of loss or profit or other matters deemed to be the result of using this unit.
- (5) The use of a printer as the peripheral device of the PLUS Copyboard is taken to be a prerequisite; therefore, operation will not be guaranteed when the printer is used with a direct connection to a personal computer.

Table of Contents

Introduction	2
Package Contents	4
Names of the Parts	5
Front	5
Input/output terminals.....	6
Changing the Height of the Unit.....	7
Control Panel.....	8
Operation Steps	9
Connecting the Power	10
Printing (printer sold separately)	11
Preparing the Printer.....	11
Basic Printing Operation	12
Moving the sheet surface manually	13
Using USB Memory	14
USB Memory Storage Procedure.....	14
Saving Image Files on a Computer/Deleting Image Files	16
Using the copyboard connected to a computer	19
Making the Device Settings	20
Meaning of Error Messages	23
Troubleshooting	24
Specifications	26
Appendix	27
Connections and Wiring Diagram.....	27

Meaning of the Terms Used in this Manual

- Main unit (or set): This refers to the copyboard.
- USB memory: refers to USB flash memory.
- USB memory storage: means the saving of sheet surface data using MEMORY (i.e., the USB port) of the operation panel. (The Copyboard has 3 USB ports.)
- Internal memory: indicates a temporary saving location of the image that has been read.
- “copy”: Both “print” and “USB memory saving” mean to “copy.”
- “Sheet surface”: refer to the drawing portion.
- “Scroll” or “move”: indicates feeding of the sheet.

Package Contents

The package contents are as described below. Please check before use.

Main unit [1]

Stand [1]

A mobile stand (with casters) for supporting the main unit. A printer table and AC adapter box are included. For the contents of the stand's package and instructions on assembly, see the stand's instructions or the separate Assembly and Setup Manual.

* Depending on the type of set you have purchased, some parts may be sold separately.

Assembly and installation parts

• Pen tray (1)

Pen tray fixing screws (M4 x 20) (temporarily fastened on main unit)

M-18S: 3 screws, M-18W: 4 screws

(See the Assembly and Setup Manual for assembly instructions.)

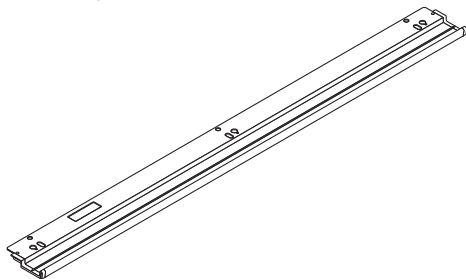

• Wall brackets (1 set)

These are brackets for mounting the main unit on a wall. (See the Assembly and Setup Manual.)

Upper wall brackets: 2

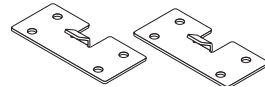

Lower wall brackets: 2

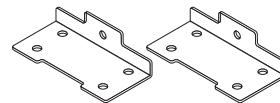

Main unit fixing screws (M4 x 12): 2



* Sold separately for some products.

• Wall mount printer table (1 set)

Bracket fixing screws (M4 x 8): 4

AC power adapter box: 1

Velcro: 2 sets

* Sold separately.

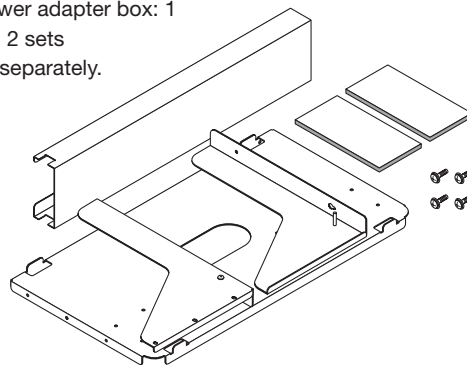

Copyboard Accessories

• Dedicated markers

(One each of black, red, blue, and green)

Use these markers to draw on the sheet surface.

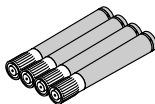

• Dedicated eraser [1]

Use this to erase the drawing.

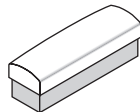

• AC power adapter (with power cord) [1]

This is the power adapter for supplying power to the copyboard (See Page E-10). (LTE36E-S2-3)

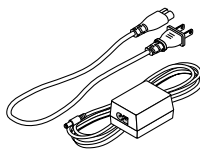

Notice

The included AC power adapter and AC power cord are exclusively for use with this unit. Never use them with other products.

• USB cable (type B ↔ type A) [1]

[PLUS code 715258900]

Cable for connecting the main unit to a computer.

Used for making the device settings.

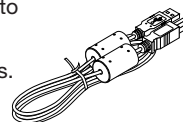

Notice

Do not use this cable for connection to the printer (sold separately).

Documents

• CD-ROM [1]

Includes the User's Manual (this manual) in PDF format.

The User's Manual contains instructions on using the copyboard.

• Important Safety Information [1]

Includes instructions to be heeded in order to use the set safely.

• Assembly and Setup Manual

Includes instructions on installing the set and connecting it with the printer (sold separately).

Names of the Parts

Front

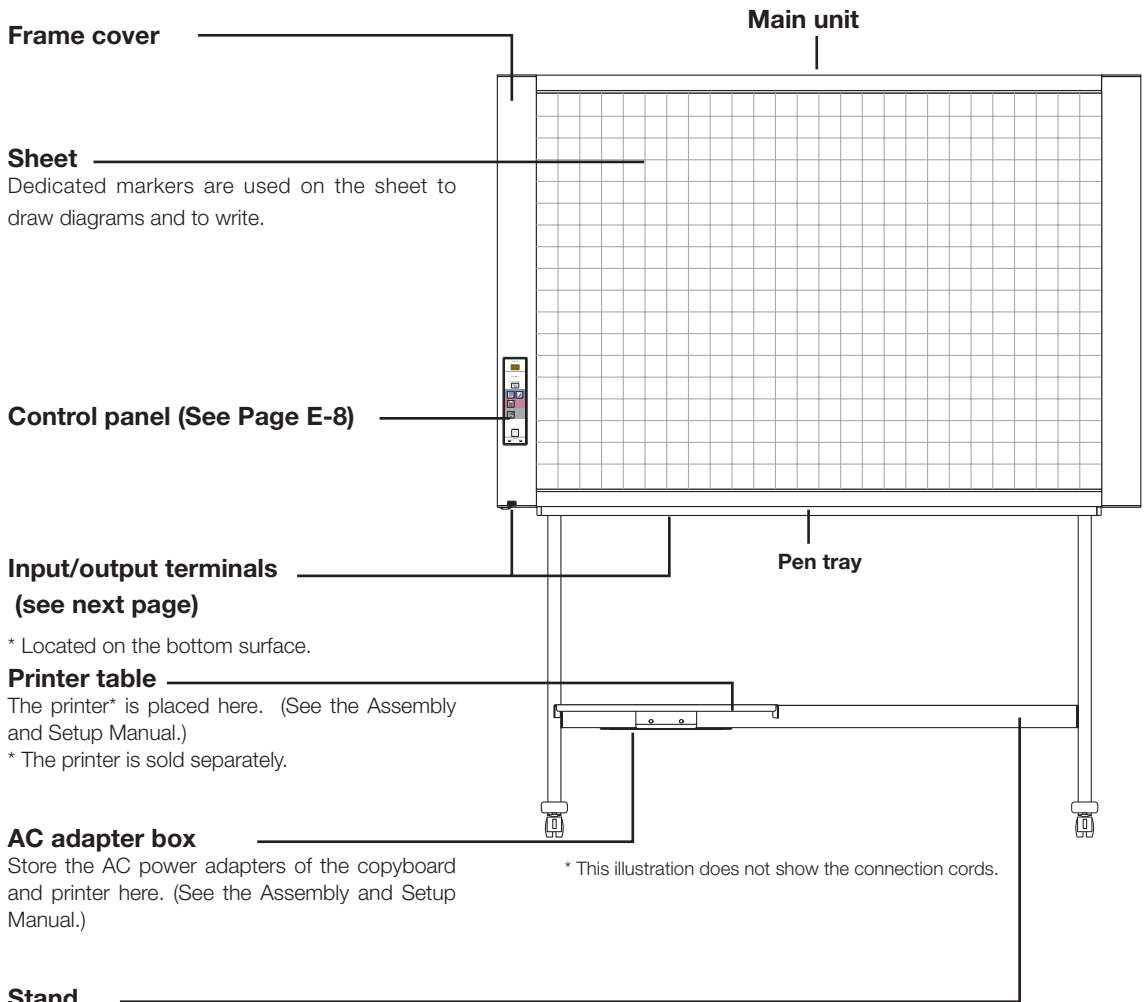

* Depending on the product you have purchased, the printer may be sold separately.

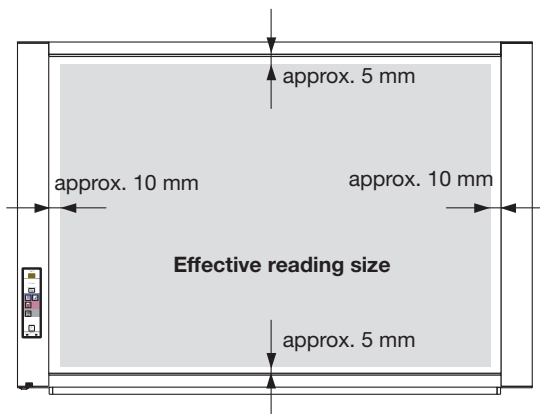

Effective Reading Size

The area that can be copied is the gray area of the diagram.

Note

- It might not be possible to print or save the portions that are drawn outside of the effective scanning area.

Input/output terminals

The connector is located on the bottom surface of the main unit.
The diagram view is seen from the bottom.

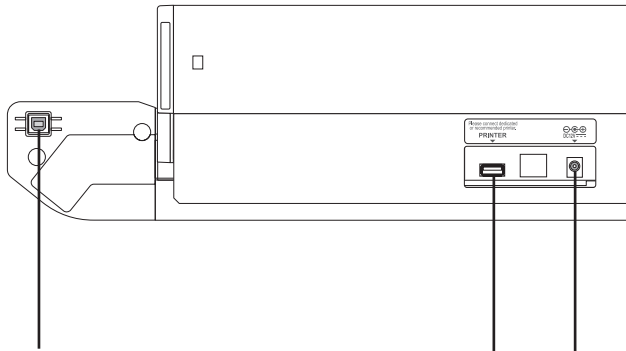

Personal computer (PC) dedicated USB port (Type B)

Connect this with the USB port (type A) of the PC.
Used to connect the copyboard to a computer to make the copyboard's device settings. Can also be used to copy scanned images onto the computer.
(See page E-19,E-20)

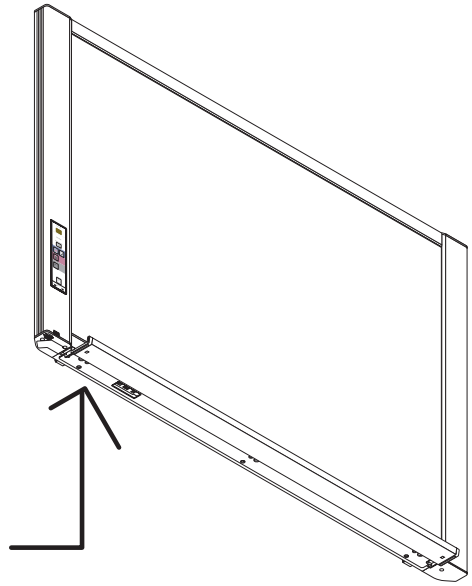

* This illustration does not show the printer or connection cords.

DC input connector

Connect this with the DC plug end of the AC power adapter. (See Page E-10.) (Only connect the supplied AC power adapter; nothing else.)

Printer connector (USB port Type A)

Connect this with the USB connector of the printer
(See Page E-27).
(The printer connector is dedicated for use with a printer; use it only with a printer.)

Locking/unlocking the stand's casters

After installation, lock the casters with the stoppers. When moving the stand, unlock the caster's stoppers.

The stoppers are locked when the bottom is pressed. Press the top to unlock them.

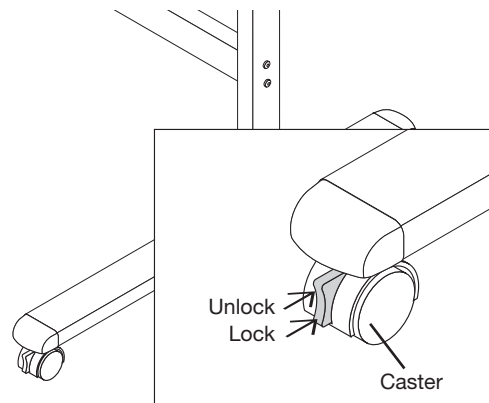

Changing the Height of the Unit

This is the height adjustment when setting up the copyboard on the optional stand. The stand height can be adjusted to 3 levels by 100 mm.

CAUTION

- At least two persons should hold the main unit. If not, the main unit could drop or tip, resulting in accidental injury.
- Lock the stand's casters by pressing the bottom of the caster lock button. If not, the stand could move while the main unit is being mounted or removed, resulting in accidental injury.
- After unplugging the power cord from the wall power outlet, disconnect all the connection cords from the set's input/output terminals. If the set is removed without disconnecting the cords, it could tip, resulting in accidental injury.
- If a printer is mounted on the set, remove the printer before starting. If not, the stand could tip while the main unit is being mounted or removed, resulting in accidental injury due to the printer dropping or tipping over.

(1) Unplug the power cord from the wall power outlet, then disconnect all the connection cords from the main unit.

(2) Remove the locking knobs (one on each side).

(3) Change the position of the main unit support pieces.

Lift the main unit about 1 cm to unhook it.

Insert the stand's hooks securely into in the mounting holes in the main unit's support pieces (one on each side).

(4) Fasten the two locking knobs (left and right) to the mount support pieces.

(5) Connect all the connection cables.

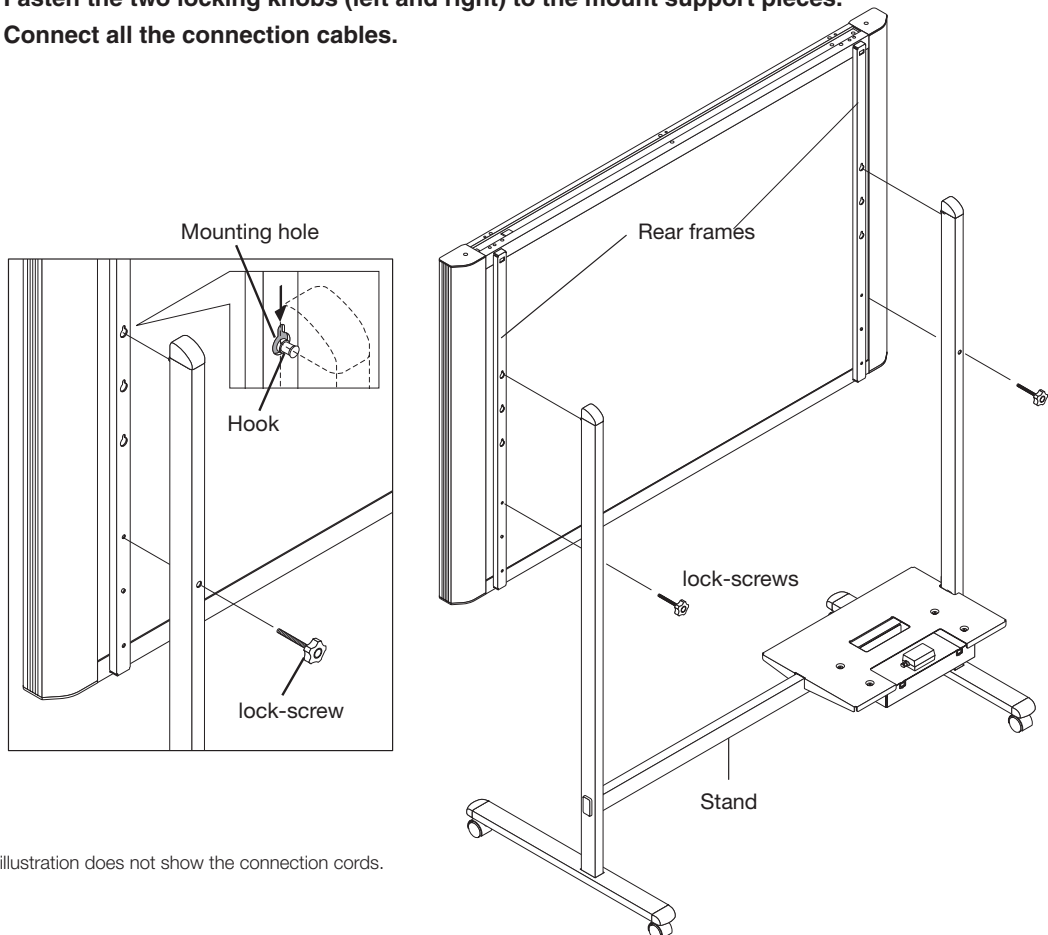

* This illustration does not show the connection cords.

Control Panel

When pressing a button, please press the center area (the square bulge). The button may not work if it is pressed on a corner.

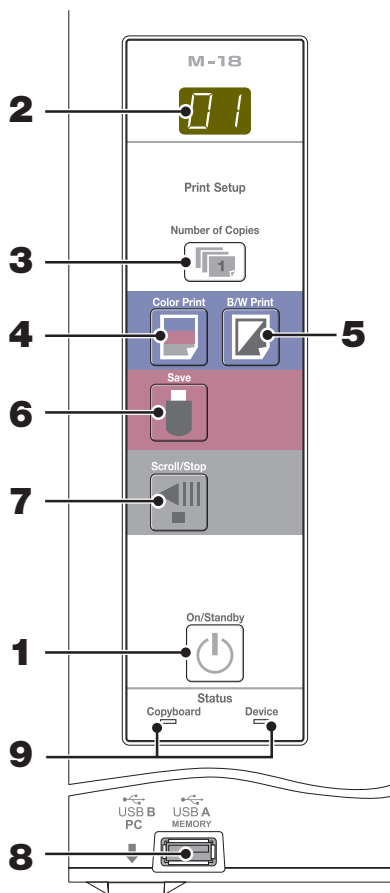

1 ON/Standby button

Turns the copyboard's power on and off (standby mode).

2 Display window

The number of copies, operating status and error messages are displayed on the 7-segment LEDs.

3 Number of Copies/Test print button

Press this button to set the number of copies to be printed (max. 10). The number of copies is displayed on the display window.

* " P " is displayed during test printing.

4 Color Print button

The sheet is moved by 1 screen and read, and the image is printed in color in the number of copies indicated on the display window.

5 B/W Print button

The sheet is moved by 1 screen and read, and the image is printed in black and white in the number of copies indicated on the display window.

6 Save button (USB memory storage)

The sheet is moved by 1 screen and read, and the image is stored on the USB memory device. When connected to a computer by USB cable, the image is stored in the copyboard's internal memory.

7 Scroll/Stop button











Scrolls the sheet one screen portion left, then stops automatically. A press of this button while scrolling will stop the scrolling.

8 USB A Memory port (USB Type A)

Saves in commercially-available USB memory images that have been read by the copyboard.



9 Status

These indicators light or turn off to indicate errors with the copyboard, USB memory device or printer. (See table at left) Also check the error message on the display window. For error information and remedies, see page E-23.

Display window	Meaning	Copyboard indicator	Device indicator
	Printer problem	Off	On
	USB Memory not recognized		
	USB Memory storage problem		
	USB memory not connected		
	USB Memory is full		
	An unsupported printer is connected		
	Warning that disconnection of USB memory has been forgotten		
	Reading problem		
	System error		
	Time setting error		

* The letters "USB" scroll on the display.

Operation Steps

The copyboard uses a CIS (Contact Image Sensor) image sensor to read the diagrams and text that have been written down with special (4-color) markers, and accumulates the image data in internal memory. The sheet surface's image data is printed out from the printer when the Color Print () or B/W Print () button is pressed, or stored as image data on the USB memory device or in the main unit's internal memory when the Save () button is pressed.

Preparation

- **Set up the newly purchased copyboard and connect a printer.**
See a separate manual titled "Assembly and Setup Manual."
- **Plug the AC power plugs of the copyboard and printer into wall power outlets. See page E-10.**
- **After purchase, be sure to set the copyboard's clock. If not, the proper date and time will not be displayed on prints or in image files. See page E-21.**

Draw on the Sheet Surface



Please draw with the dedicated markers that have been supplied.

If anything other than the dedicated markers or eraser are used, it may be impossible to erase the sheet or the sheet could get dirty.

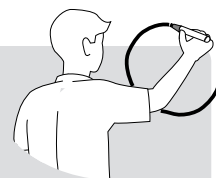
To move the sheet manually, see "Moving the Sheet Surface Manually" on page E-13.



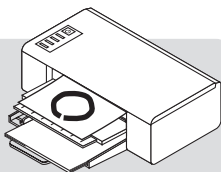

Printing

- (1) Set A4 or letter size paper.
Do not set anything other than A4 or letter size paper.
- (2) Press the ON/Standby () button of the copyboard and switch on the power.
- (3) Switch on the printer power.
For instructions on operating the printer, see the printer's operating instructions.
- (4) Press the Color Print () or the B/W Print () button. The copyboard will move a one-screen portion of sheet, read the image, and start the copy operation*.
See "Printing" on Page E-11.



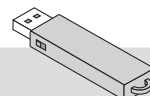

Saving to USB Memory

- (1) Press the ON/Standby () button of the copyboard to switch on the power.
- (2) Insert USB memory into the Memory () port (USB A port) of the copyboard.
- (3) Press the Save () button.
See "Using USB Memory" on Page E-14.





Saving on a computer

- (1) Press the copyboard's ON/Standby () button to turn the power on.
- (2) Connect the copyboard to the computer using the PC dedicated USB port.
- (3) Press the Save () button.
- (4) The image is saved on the computer.

When Not Using the Copyboard

- (1) By all means, cleanly erase the drawing from the sheet surface with the dedicated eraser. (Leaving the drawing for a long period will make it harder to erase.)
- (2) Press the ON/Standby () button of the copyboard and switch off the power (standby mode).
The power cannot be switched off while the USB memory remains installed. (This is a prevention function against forgetting to unplug the USB memory.)
- (3) Switch off the printer power.

Note

- When connecting the power plug, the flashing LED indicator in the display window starts to rotate for about 5 seconds. Make sure to press the On/Standby () button to power on the copyboard when the flashing LED indicator goes off.
- The color of the images when printed in color or when saved in USB memory will differ somewhat from the marker colors.
- Blurred characters, thin lines, overlapping of markers and other factors can cause colors to differ in places and can also result in portions that cannot be scanned successfully.
Also, black may be mixed in (for color prints) and ruled lines may be scanned.
- Data in the internal memory is cleared when the power is turned off (set to standby) with the power () button or when the computer is disconnected.

Connecting the Power

Note

About the connection and the AC adapter box

Place the AC power adapters of the main unit and printer in the AC adapter box.

If you only have one power outlet, connect the AC power adapters of the main unit and printer to a commercially available cable tap, place them in the AC adapter box, and connect the cable tap's power plug to the wall power outlet.

Also, if not connected or placed in the AC adapter box, see the separate "Assembly and Setup Manual" and connect according to the purpose.

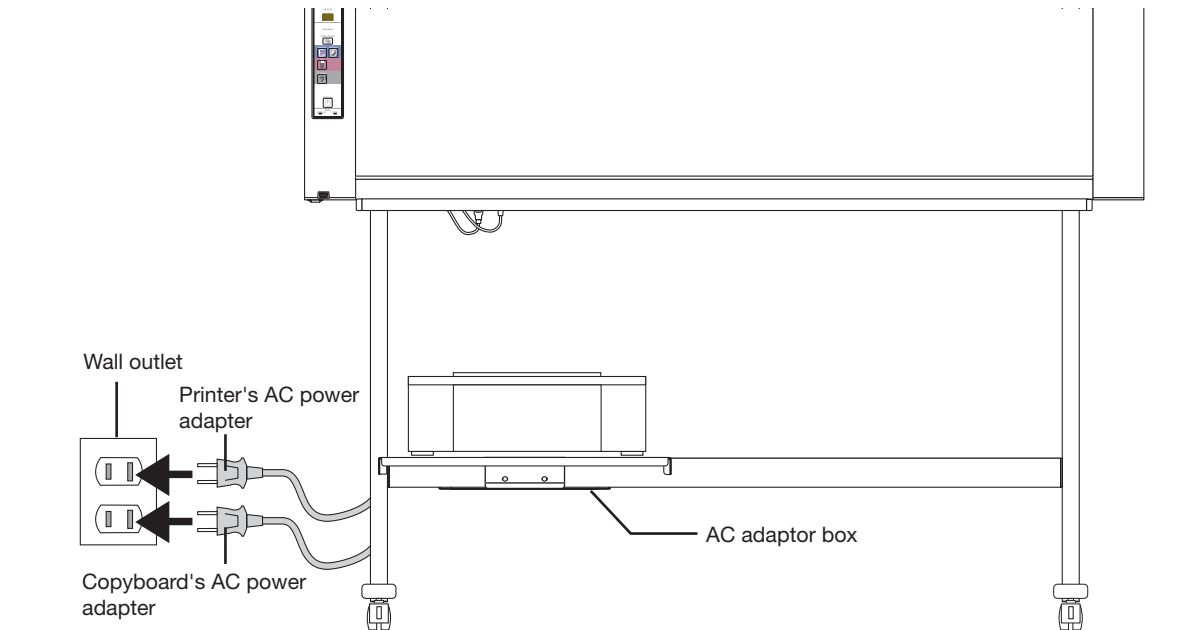

* Be sure to insert all the plugs securely.

To use the copyboard, connect the copyboard's AC power plug to a wall power outlet.

The main power turns on. In this manual, this is referred to as the "standby mode".

The descriptions in this manual assume that the AC power plug is connected (that the unit is in the standby mode).

About the printer's power supply

- When using a printer, connect its power plug to a wall power outlet.
Also, turn on the printer's power before printing.

When not using the copyboard for long periods of time

Disconnect the AC power adapter's power plug from the AC power outlet in the wall.

Notice

- When the AC power adapter's power plug is unplugged from the power outlet, place the copyboard near the power outlet so that it can be reached easily.
- The supplied AC power adapter and AC power cord are intended for exclusive use with this product. Never use them with another product.

Printing (printer sold separately)

Use a printer to print out the image that has been drawn on the sheet surface. Use a PLUS-designated printer. Operations and names of parts differ from printer to printer. For details of operations, see your printer's operating instructions.

Preparing the Printer

Please check that the copyboard and the printer have been connected. See Page E-27.

1

Set the paper.

Please use A4 or letter size printer paper.

- When using letter size paper, set letter size paper in the device settings. (See page E-20.)
- 1) Arrange the paper edges so that they are even.
 - 2) Insert paper at the specified position of the paper tray.
 - 3) Press the paper guide gently until it touches the paper.

Note

See your printer's operating instructions for a description of the paper that can be used.

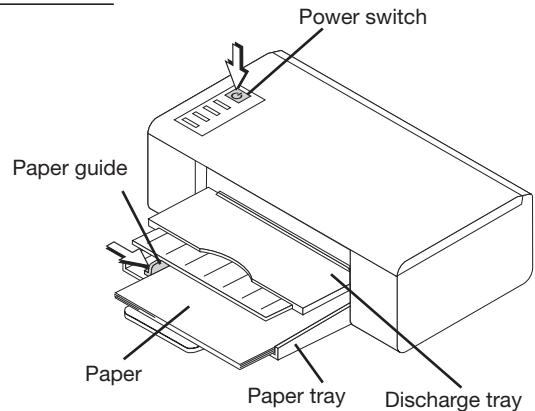

Appearance of printer is for illustration purposes.

2

Switch on the power.

Press the power switch. The power indicator lights.

This completes the preparation of the printer.

Press the Color Print or the B/W Print button on the copyboard's control panel. One page worth of data is read and the printing operation starts.

Note

- Depending on the printer, indicators, etc., may flash after the power is turned until the printer is prepared to print. In this case, see the printer's operating instructions and check that the printer is ready before starting the printing operation on the copyboard.

3

When finished printing...

Switch off the printer power and remove the paper. Close the paper tray.

Notice

- Caution: Do not turn off the power or disconnect the USB cable during printing.

Basic Printing Operation

Preparation:

Preparation: Check that the AC power plugs of the copyboard and printer are connected to wall power outlets. See Page E-10.

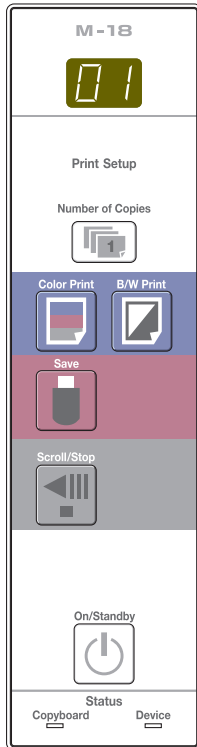



1

Press the ON/Standby  button and switch on the power.



Prepare the printer. (See the previous page.)

Note

- When turning on the power, wait about 5 seconds after connecting the copyboard's AC power plug to the wall power outlet or after turning off the power (standby mode) before pressing the ON/Standby  button.
- Press the ON/Standby  button to switch on the power. The LED of the display window will light.
- Turn on the copyboard's power before turning on the printer's power.

2

Press the Scroll/Stop  button and display the sheet surface you want to print.

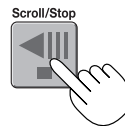

A press of the Scroll/Stop  button scrolls the sheet surface one screen portion left and automatically stops it.

To stop the operation part way through, press the Scroll/Stop  button again.

Note

- The one-screen that is visible is printable position.
- To fine-adjust the sheet surface position, with the sheet stopped, move the sheet slowly by hand. The sheet can be moved either to the left or to the right.
- Printing of the portion located around the sheet surface might not be possible. Please see "Effective reading size" on Page E-5.

3

Press the Number of Copies  button and select the number of copies.

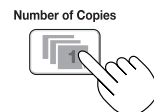

Note

- "01" is selected when the power is turned on.
- Up to 10 copies can be specified and displayed on the display window.
- The number of copies increases by 1 each time the Number of Copies button is pressed, and " P" is displayed after "10" (this is used for test printing). When the button is pressed again, the display switches to "01". The number switches continuously if the button is held in.
- After setting the number of copies, proceed to step 4 within 1 minute. The number of copies is reset to "01" if no operation is performed within 1 minute.

4

Press the Color Print  or the B/W Print  button to print.

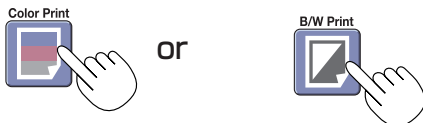



- The reading operation is performed for a one-sheet portion (while the sheet is scrolled) and the printing operation is performed.

Cancellation of the print operation in progress

When the ON/Standby  button is pressed, the reading of the sheet stops, and the partially read image data is printed. Wait until the sheet is expelled from the printer.

Note

- If the ON/Standby  button is pressed while the sheet surface is being read, printing is interrupted and only part of the image will be printed.
To move the sheet surface, wait until scrolling stops, then press the Scroll/Stop  button .
- The one-screen portion is reduced to A4 paper size and printed.
For wide type copyboards (model M-18W), the image is compressed about 75% in the horizontal direction. To print with the same proportions as the image on the sheet surface, see "Making the Device Settings" (page E-20).
- A flashing "E 1" in the display window indicates a print error. See "Meaning of Error Messages" on Page E-23.
- When printing, a time stamp (date and time) is printed at the top right of the sheet. See "Making the Device Settings" on page E-20.

5

When the copyboard is not going to be used, press the ON/Standby  button and switch off the power (standby mode).

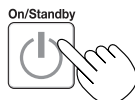

- Switch off the printer power.

Note

- If no button is operated within 30 seconds, the power turns off automatically (auto power off).
When the power is turned off, scanned images stored in the unit's internal memory are cleared.
- The auto power off function is canceled when the copyboard and computer are connected by USB cable.

Moving the sheet surface manually

The sheet can be moved even when the power of the copyboard is switched off.

The sheet can be moved with your hand either in left or right. Please place your hand at the vertical center and move the sheet slowly.

Notice

Quick movement can cause damage to the drive mechanism of the copyboard.

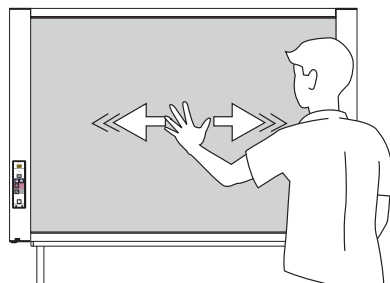

Using USB Memory

The content of what has been drawn on the sheet surface of the copyboard can be saved in USB memory. Later, the saved image can be read into a personal computer and made into a document of the proceedings of the meeting, or affixed to a document.

Notice

- No USB flash memory device is included. When purchasing a USB flash memory device, pay attention to the following:
 1. USB flash memory devices formatted in FAT16/FAT32 are supported. USB flash memory devices in NTFS format cannot be used.
 2. USB flash memory devices protected by a security function cannot be used.
 3. USB flash memory devices with a capacity of over 32 GB cannot be used.
 4. If the USB flash memory device is divided into multiple partitions, only one partition can be recognized with this unit.
- See the PLUS website for more information on USB memory devices usable with this unit.

USB Memory Storage Procedure

Preparation:

Check that the copyboard's AC power plug is connected to a wall power outlet. See page E-10.

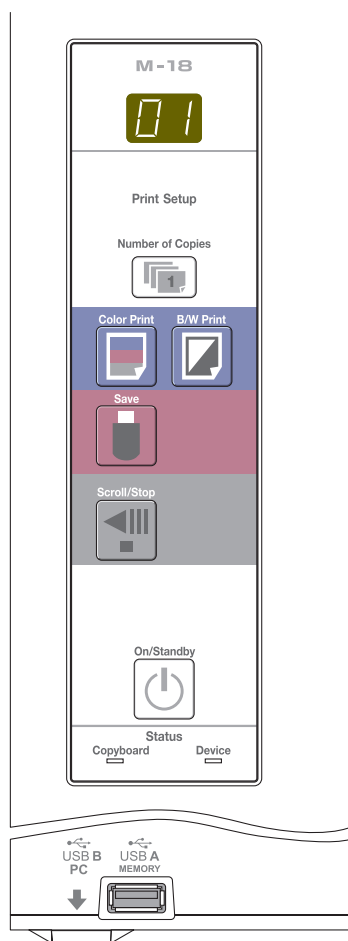

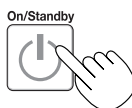

1

Press the ON/Standby  button and switch on the power.



Note

- When turning on the power, wait about 5 seconds after connecting the copyboard's AC power plug to the wall power outlet or after turning off the power (standby mode) before pressing the ON/Standby  button.
- Press the ON/Standby  button to switch on the power. The LED of the display window will light.

2

Insert the USB memory device into the USB A Memory  port of the copyboard.

Notice

- Check the side (polarity) of the USB memory device before inserting it. Forcing it in the reverse orientation will damage the USB A Memory port or USB memory device.
- Be careful not to bump into the USB memory device with hand or body while it is mounted. Doing so could damage the USB memory device or USB A Memory port.

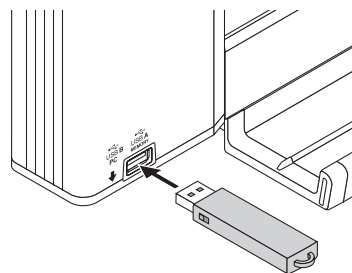

3

Press the Scroll/Stop  button and display the sheet surface you want to store.

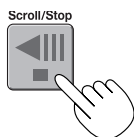

The procedure for displaying the sheet surface you want to store is the same as for printing.
See “Basic Printing Operation” on page E-12.

Note

- The one screen portion that is viewable will be saved in USB memory.
- Saving of the portion located around the sheet surface might not be possible. Please see “Effective reading size” on Page E-5.

4

Press the Save  button to store.



Flashing indicator “rotates” sequentially during USB memory storage operation.

Display window

- The reading operation is performed for a one-sheet portion (while the sheet is scrolled) and USB memory storage starts after the scrolling completes.







The (5 second) flashing “US” display indicates that the USB memory has not been inserted. Please insert the USB memory and then press the Save  button.



A (5 second) flashing “FL” display indicates that there is insufficient free capacity to permit storage in USB memory. The flashing display will stop when the USB memory device is removed. Replace with a USB memory device having sufficient capacity.

See “Meaning of Error Messages” on Page E-23 for other error displays.

Note

- Depending on the USB memory, it may take time for recognition or it may take time for saving.
- When the ON/Standby  button is pressed during the reading operation, the reading operation will be discontinued and the partially read image data will be stored in the USB memory.
To move the sheet surface, wait until scrolling stops, then press the Scroll/Stop  button.
- The date and time of the saved file will reflect the copyboard time setting. See “Making the Device Settings” on Page E-20.
- When a certain amount of free capacity is not available in the USB memory, “FL” will be displayed when the Save  button is pressed. Also, when insufficient free capacity arises during saving, “FL” is displayed at that point. Delete data, set the sheet surface back to the original status, then press the Save  button again.
- When the copyboard and a computer are connected by USB cable, the data is stored in the main unit’s internal memory.

5

Removing the USB memory

Check that the flashing rotation of the display window has changed to steady lighting and that the USB memory access indicator is not flashing, then pull the USB memory straight out. (Please see your USB memory manual for details.)

Notice

- Do not unplug the USB memory device during the USB memory storage operation (i.e., during the rotating, flashing display in the display window), or while the access indicator of the USB memory device is flashing because data will be destroyed.

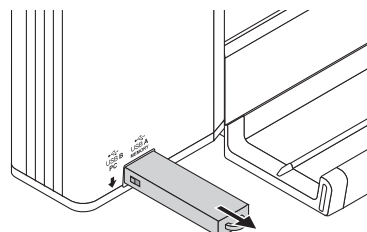

6

When the copyboard is not going to be used, press the ON/Standby  button and switch off the power (standby mode).



Note

- "USB" letters appearing at one-second intervals in a moving display in the display window indicate that a USB memory device is mounted. Unplugging the USB memory device will switch off the power. (A function that serves as a reminder to unplug the USB memory device)
- When the copyboard and a computer are connected by USB cable, the auto power off function (which turns the power off automatically) is canceled.
- Scanned image files stored in the copyboard's internal memory are cleared when the power is turned off (set to standby) with the ON/Standby  button or when the computer is disconnected.

Saving Image Files on a Computer/Deleting Image Files

Examples of operations follow for saving the image files in the USB memory device to the hard disk of the personal computer, and for deleting the folder when the USB memory capacity is full. (There are various methods that can be used for saving and deleting including the use of Explorer.) See the instruction manual of your personal computer or the software that you are using for information about using a personal computer.

The copyboard's folder on the USB memory device is named "CB_image". The images are stored in this folder.

Image files are named "PV-xxx.jpg" (JPEG files), where "xxx" is an assigned 3-digit number starting from 001 (ex.: PV-001.jpg). For North American models only, image files are named "PV-xxx.pdf" (PDF files).

Note

The format in which the image files are stored can be set to "JPEG". For North American models only, image files are stored in PDF format.

1

Plug the USB memory device into a USB port of the personal computer

When connecting to the personal computer for the first time, the installation of a USB driver is required. Follow the instructions manual of the USB memory device that you are using.

- Usually, with Windows XP/Windows Vista/Windows 7, the standard driver is installed automatically and the copyboard is identified as "Removable disk" in "My Computer" (or "Computer").

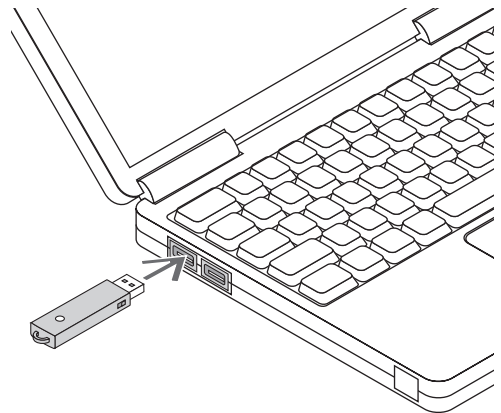

2

Saving the image files of a USB memory device to a personal computer

1. Open “My Computer (or "Computer")” and from within, open the drive of the connected USB memory device.

The folder named “CB_image” is the saved data of the copyboard.

2. Store the “CB_image” folder in “My Documents” or another location.

All of the data contained in “CB_image” will be stored.

Notice

Depending on the computer's usage environment, these operations may not work properly. This could be the case for example:

- when several USB devices are connected simultaneously to the computer.
- when the USB device is connected to a USB hub or when it is connected using an extension cable.

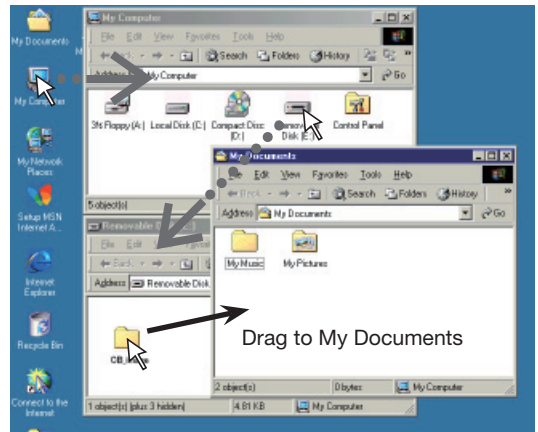

Deleting USB memory image files with the computer

Before deleting important image files, be sure to save them on the computer (as a data backup).

1. Open “My Computer (or "Computer")” and then open the drive icon which shows USB memory.

The folder named “CB_image” contains the memory storage data of the copyboard.

2. Place the “CB_image” folder in the “Recycle Bin”, right click on the icon and select “Empty Recycle Bin” from the pull-down menu.

All of the data contained in “CB_image” will be deleted.

Even when the entire folder is deleted, a new CB_image folder will be created automatically when USB memory is used again with the copyboard.



3

Disconnect the USB memory

The disconnecting procedure depends on the computer's operating system. For details, refer to the computer's operating instructions or help files.

1. Click the **[Hardware Removal]**  icon that is displayed in the task tray.

Click "Stop USB Mass storage Device - drive (E)". (The E drive character will differ depending on the personal computer system.)

2. Click **[OK]** when "The 'USB Mass storage Device' device can now be safely removed from the System" is displayed.

(When using Windows XP/Windows Vista/Windows 7, [OK] does not appear on the message screen. Simply disconnect.)

3. This allows the USB memory device to be unplugged from the computer.

Note

- Do not disconnect the USB memory device while the USB memory device's access indicator is flashing. Doing so will damage the data.
- The USB drive may not be disconnected properly, for example if the computer is in the process of checking the status of peripherals.

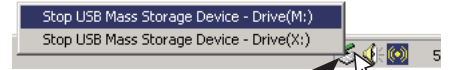

"Remove hardware" icon (example)



Using the copyboard connected to a computer

When the copyboard and a computer are connected by USB cable, the copyboard is recognized as an external memory device (removable device). Below is the procedure for copying the "CBImage.JPG" file from this device onto the computer. The format in which the image files are stored can be set to "JPEG". For North American models only, image files are stored in PDF format.

Notice

- Only one sheet's worth of data can be stored in the copyboard's internal memory. When the storage procedure is performed successively on the copyboard, the data is overwritten.
- The image data in the copyboard's internal memory is cleared when the USB connection between the copyboard and computer is cut off.
- Do not save data from a computer into the copyboard's internal memory.
- The copyboard's internal memory cannot be formatted from a computer.
- Do not disconnect the USB cable or access the copyboard while the data is being saved after pressing the copyboard's Save () button/. Doing so may cause operation of the computer to become unstable.
- Do not press any operation buttons on the main unit while the copyboard's internal memory is being accessed from the computer. The response time could be long and the operation may not be possible.

1 Turn on the copyboard's power and connect the PC dedicated USB port (type B) and computer using the USB cable.

- Usually, with Windows XP/Windows Vista/Windows 7, the standard driver is installed automatically and the copyboard is identified by the computer as a removable device.

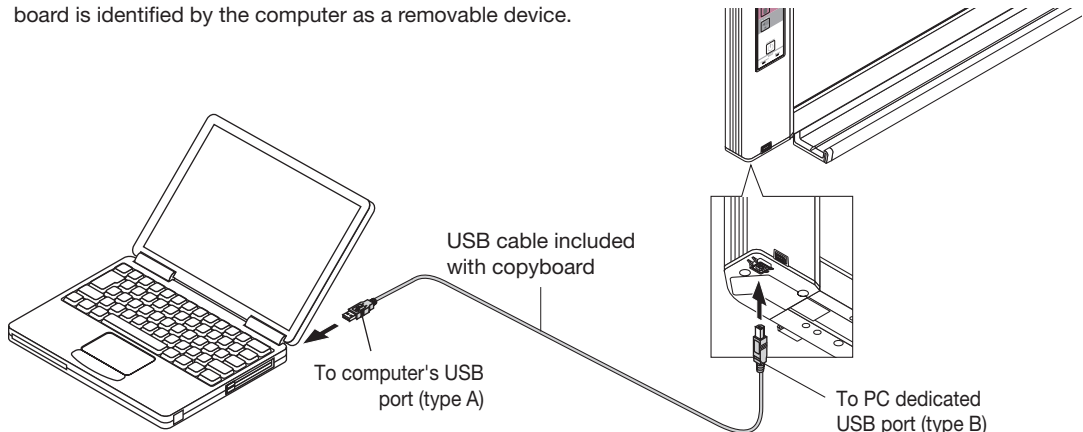

2

On the computer, open "My Computer", and from there open the copyboard identified as a removable device.

(1) Double-click the "My Computer" (or "Computer") icon to open it.

(2) When the device icon for the copyboard (displayed as a removable disk) is double-clicked, the copyboard's internal memory opens.

The "CBImage.jpg" file is the scanned image file.

- The "setup" folder contains the copyboard settings file.
- To check the copyboard's operation as a device, right-click [My Computer] (or [Computer]) to display the menu, then at Administration -> Device Manager in Windows 7 (Properties -> Device Manager in Windows XP), check that "PLUS Copyboard USB Device" is displayed as the disk drive name.

(3) Copy the "CBImage.jpg" file to [My Documents], etc., on the computer.

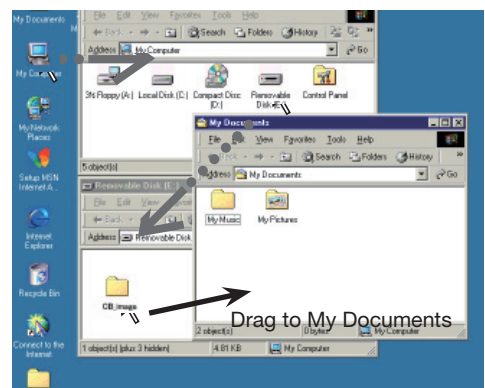

To disconnect the USB cable, follow the procedure in step 3 on the previous page.

Making the Device Settings

Make the copyboard's device settings (paper size, aspect ratio setting and time setting) using a computer. When the copyboard and a computer are connected, the copyboard is recognized as an external memory device (removable device).

Notice

- Do not save data from a computer into the copyboard's internal memory.
- The copyboard's internal memory cannot be formatted from a computer.
- Do not disconnect the USB cable or access the copyboard while the data is being saved after pressing the copyboard's Save () button/. Doing so may cause operation of the computer to become unstable.
- Do not press any operation buttons on the main unit while the copyboard's internal memory is being accessed from the computer. The response time could be long and the operation may not be possible.

Before making the device settings

The copyboard's device settings screen is created using Adobe® Flash®. Settings are made by opening a web browser. Because of this, a web browser and Adobe Flash Player 10 for displaying the device settings screen must be installed on the computer. If Adobe Flash Player 10 is not installed on the computer, download it (free of charge) from the Adobe website.

1 Turn on the copyboard's power and connect the PC dedicated USB port (type B) and computer using the USB cable.

- Usually, with Windows XP/Windows Vista/Windows 7, the standard driver is installed automatically and the copyboard is identified by the computer as a removable device.

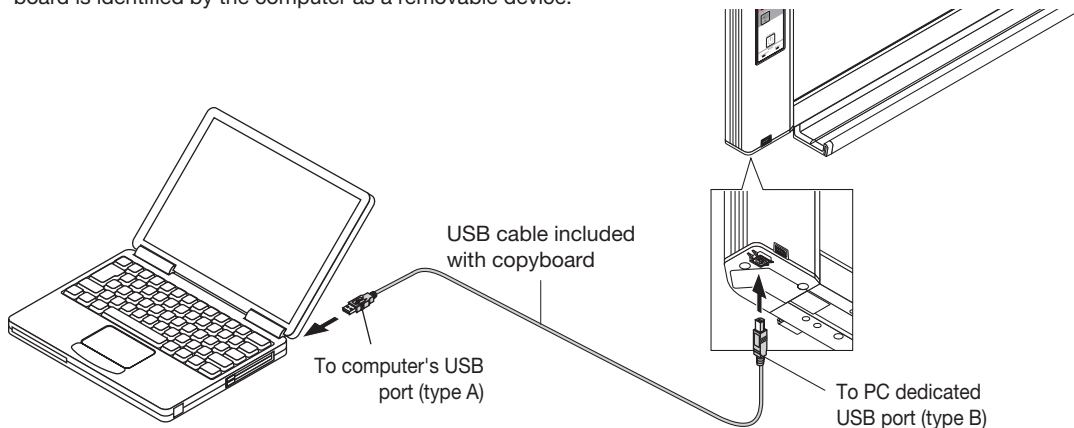

2 Open [My Computer], and from there open the copyboard identified as a removable device.

- (1) Double-click the "My Computer" (or "Computer") icon to open it.
- (2) When the device icon for the copyboard (displayed as a removable disk) is double-clicked, the copyboard's internal memory opens.
 - To check the copyboard's operation as a device, right-click [My Computer] (or [Computer]) to display the menu, then at Administration -> Device Manager in Windows 7 (Properties -> Device Manager in Windows XP), check that "PLUS Copyboard USB Device" is displayed as the disk drive name.

3 Open the "CBSetup" file in the "setup" folder.

- (1) Double-click the "setup" folder to open it.
- (2) Open the file in the "setup" folder with your web browser.
 - * With Internet Explorer, a security warning may appear. To cancel it, see page E-22.
 - * Depending on the browser's version, etc., the file may not open. In this case, open the "setting.ini" file (in text format) using Notepad or another application on the computer and rewrite the contents of the settings file directly. (See page E-22)

Making the Device Settings

4

Make the device settings and save the "setting.ini" settings file, overwriting the previous file.

- (1) Make the settings.

Settings:

For the paper size and aspect ratio, click the radio button for the desired item to select it.

Time Day Stamp:

For the time day stamp, use the computer's number keys to input the current date and time.

- (2) If you have changed the copyboard's device settings, click the "Set" button for the "Settings" section.

If you have changed the date/time setting, click the "Set" button for the "Time Day Stamp" section.

- (3) The save file screen appears when one of the "Set" buttons is pressed. Save the "setting.ini" file (overwriting the previous file) in the following location:

Save to location: "setup" folder for the copyboard (removable disk)

File name: setting.ini

- (4) Close the web browser.

This completes the device settings.

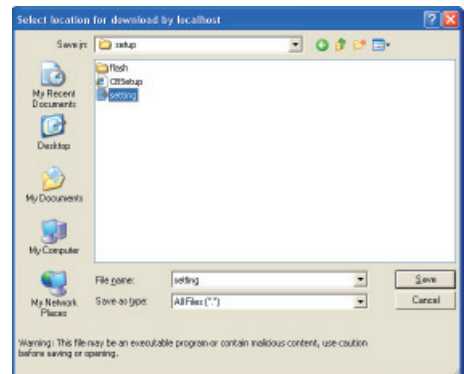
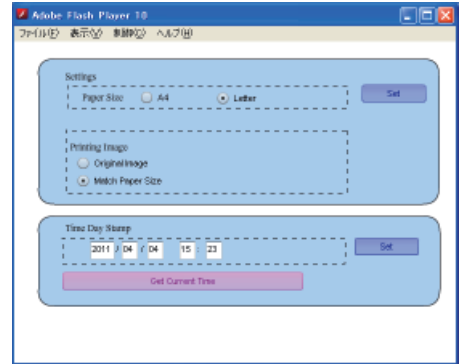

Item Name	Description	Default Setting
Paper Size	Sets whether to print on the printer in A4 or letter size. A4 size printing range: Equal ratio – 145 x 287, Compressed – 195 x 287 Letter size printing range: Equal ratio – 136 x 269, Compressed – 206 x 269	North America: Letter Others: A4
Printing Image	This is only selectable on wide type copyboards. This selects the vertical:horizontal aspect ratio of the image when printing. Original Image: Image is printed with the same aspect ratio as on the copyboard's sheet surface. Match Paper Size: Image is compressed horizontally to the A4 or letter size paper's aspect ratio (ex.: circles become ovals).	Match Paper Size
Time Day Stamp	Input the current date and time. The entry fields are as follows (in order): Year / Month / Day / Hours: Minutes Input as follows: Year: 4 digits, Month: 2 digits (ex.: 03 for March), Day: 2 digits (ex.: 06 for the sixth), Hours: 2 digits in 24-hour format (ex.: 14 for 2:00 pm, 06 for 6:00 am), Minutes: 2 digits (ex.: 00 for 0 minutes) * Do not input spaces. If this is done, the file will be recognized as corrupt when the copyboard is started and the settings will be reset to the defaults. Get Current Time : When "Get Current Time" button is clicked, the display switches to the computer's current time. This eliminates the need to set the current time on the copyboard.	

Making the Device Settings

Note

Rewriting the "setting.ini" settings file directly

Depending on the browser's version, etc., the file may not open. In this case, open the "setting.ini" file (in text format) using Notepad or another application on the computer and rewrite the contents of the settings file directly.

Description example:

```

Date=2011/02/03 ..... Date
Time=00:00 ..... Time
A4Page=0 ..... Paper size
Stretch=1 ..... Printing Image
    
```

Item	Item Name	Setting Value (numbers to be input)	Restrictions
Date	Date	Current date	Use "/" to separate the year, month and day.
Time	Time	Current time (24-hour mode)	Use ":" to separate the hours and minutes.
Paper size	A4Page	Set to "0" for letter size, "1" for A4 size.	
Printing Image	Stretch	Set to "0" to print the image as it is on the sheet surface. Set to "1" to fit the image to the printing paper.	Only settable for wide type copyboards

* See the previous page for details on the settings.

* Do not input spaces. If this is done, the file will be recognized as corrupt when the copyboard is started and the settings will be reset to the defaults.

- (1) After the file has been rewritten, save it, overwriting the previous "setting.ini" settings file.
 Save to location: "setup" folder for the copyboard (removable disk)
 File name: setting.ini
- (2) This completes the device settings.

• Canceling the Internet Explorer security warning

If a security warning is displayed when the device settings file is opened with Internet Explorer, it can be canceled using the procedure below.

The explanation in this example is for Windows XP.

- (1) Click the warning bar.
 A pop-up menu appears.

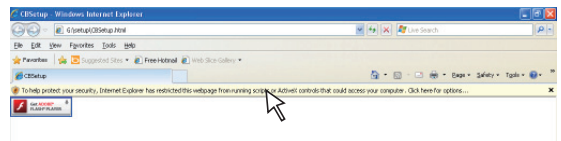

- (2) Click "Allow blocked content (A)...".
 The security warning screen appears.

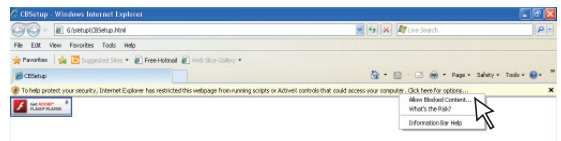



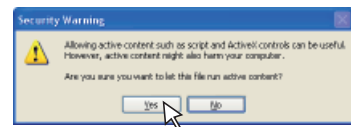

- (3) Click "Yes (Y)".
 This cancels the warning. The device settings file opens.

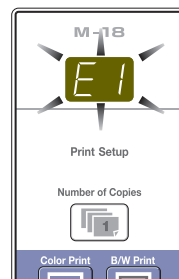

Meaning of Error Messages

If any of the following flashing indications appear in the display window of the control panel, please check the matters described below.
Error messages flash for 5 seconds, then stop flashing, remaining lit.

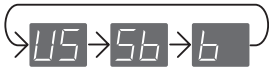

Error Display Number	Problem and Solution	
E1 Printer not connected No printing paper Printer problem	<ul style="list-style-type: none"> Is the printer cable connected? Is power being supplied to the printer? When the printer uses an AC power adapter, is the cable disconnected somewhere? 	<ul style="list-style-type: none"> Connect the printer properly and switch on the printer power.
E2 USB Memory not recognized	<ul style="list-style-type: none"> Has paper been set in the printer? 	<ul style="list-style-type: none"> Turn the power of the printer off and then on again, and load the printer with A4 or letter size paper.
	<ul style="list-style-type: none"> Is the printer error indicator flashing (or lit)? 	<ul style="list-style-type: none"> Read the printer instruction manual.
	<ul style="list-style-type: none"> Is the USB memory unformatted. 	<ul style="list-style-type: none"> This unit supports the FAT and FAT 32 formats. Perform the formatting with the personal computer.
E3 USB Memory storage problem	<ul style="list-style-type: none"> Is a USB memory that is not supported by the copyboard being used? 	<ul style="list-style-type: none"> Please see our home page for information about USB memories that can be used with the copyboard.
	<ul style="list-style-type: none"> Is the USB memory device plugged in fully? 	<ul style="list-style-type: none"> Please check the operation with a personal computer.
	<ul style="list-style-type: none"> Is the USB memory damaged? 	
E4 Reading problem	<ul style="list-style-type: none"> An error occurred during USB memory storage. 	<ul style="list-style-type: none"> Please perform USB memory storage again. Do not insert or remove the USB memory during processing.
E5 System error	<ul style="list-style-type: none"> There is a lighting fault of the reading light source, or a read signal error. 	<ul style="list-style-type: none"> Unplug the power plug from the power outlet and then plug it in again.
E5 System error	<ul style="list-style-type: none"> There is a memory or internal fault. 	<ul style="list-style-type: none"> Unplug the power plug from the power outlet and then plug it in again.
U5 USB memory not connected	<ul style="list-style-type: none"> USB memory device is not plugged into the main unit. 	<ul style="list-style-type: none"> Plug the USB memory device into the USB port.
FL USB Memory is full	<ul style="list-style-type: none"> There is no available space. 	<ul style="list-style-type: none"> Please delete unnecessary data using a personal computer (See Page E-16).
EL An unsupported printer is connected	<ul style="list-style-type: none"> A printer that is not supported by the copyboard has been connected. 	<ul style="list-style-type: none"> Press the ON/Standby  button and switch off the power. When a record is required, switch on the power and save to USB memory.
E4 Time setting error	<ul style="list-style-type: none"> An error has arisen when setting the time. 	<ul style="list-style-type: none"> Start setting the date/time over from the beginning.
When the "USB" letter display is flowing...Warning that disconnection of USB memory has been forgotten 	<ul style="list-style-type: none"> Did you press the ON/Standby  button while the USB memory device was plugged into the main unit? 	<ul style="list-style-type: none"> A USB memory device is plugged into the main unit. When the USB memory device is disconnected, the power will be switched off and the unit will enter the standby mode.

If the problem persists, please contact your nearby PLUS Corporation sales office, dealer, or store.

Troubleshooting

Please check the following matters before making a request for servicing.



Condition		Please Check
Copyboard Related	Pressing the ON/Standby (⏻) button does not switch on the power.	<ul style="list-style-type: none"> Check whether the cable of the AC power adapter is disconnected from the DC connector of the Copyboard or the wall outlet. (Unplug the AC power cable from the outlet, wait several seconds and then plug it back into the outlet again.)
	Writing on the sheet is not erased with the eraser.	<ul style="list-style-type: none"> Was a marker other than a dedicated marker used?
	Portions of writing or lines are not printed or stored in memory.	<ul style="list-style-type: none"> Portions of blurred characters or thin lines may not be printed or stored in USB memory.
	Scanned copy (image) is dirty, Erase Reminder function is activated even when sheet is erased with the eraser	<ul style="list-style-type: none"> Is there marker residue or substantial quantities of refuse on the sheet? (If the sheet is dirty, moisten a soft cloth with water, wring well, then wipe the sheet in a stroking manner.)
	When the copyboard and PC are connected, the PC does not recognize the copyboard	<ul style="list-style-type: none"> Check whether the copyboard is in an operable condition, and whether the USB cable is connected properly. Is the copyboard connected to the PC via a USB hub? (Connect the copyboard directly to the USB port of the PC.)
	The date is not updated.	<ul style="list-style-type: none"> The copyboard's battery is dead. Contact your store of purchase.

* If the problem persists, please contact your nearby PLUS Corporation sales office, dealer, or store.

Condition		Please Check
Printer Related	The copyboard's power turns on, but the printer's power does not.	<ul style="list-style-type: none"> Check whether the printer's power plug (DC plug) is securely inserted. If the power still does not turn on, disconnect the AC adapter box and check whether the printer's AC power adapter side plug is unplugged from the AC power adapter. (For some printers it is directly mounted.)
	A press of the Print button does not result in printing.	<ul style="list-style-type: none"> Check that the power cable of the printer and the printer cable are securely connected. Check that the printer power indicator is lit. Check that the error indicators of the copyboard and the printer are not lit. If the error indicator of the copyboard is flashing, please see Page E-23. (Please see the printer instruction manual for information about printer errors.)
	The paper feed is abnormal.	<ul style="list-style-type: none"> Possible causes include damp paper, overly thin or thick paper, only one sheet of paper is set, and a curved setting of the paper. (Please see the instruction manual for your printer.)
	An altered color is printed, not the specified color.	<ul style="list-style-type: none"> Please replace the print cartridges with new ones.
	There is no printing.	<ul style="list-style-type: none"> Check that the print cartridge is properly set. Check that the print cartridge is not plugged.
	<ul style="list-style-type: none"> Print is very pale, there are white lines on it, or page is dirty. Printed colors are very different from those of the markers that were used. 	<ul style="list-style-type: none"> Is the print cartridge's nozzle partially choked? ◆ Make a test print and check the conditions of the nozzle.

Continued on next page

Test Printing

- 1) With the copyboard's power on (with the display window lit), press the Number of Copies button repeatedly to display " P " on the display window.
- 2) Press the Color Print () button for a color print, the B/W Print () button for a black-and-white print.

* Test printing starts.

Check the print

- Is the each color line printed uniformly?
- Are there missing dots, pale lines, lines with thinner ink than others, etc.?

Remedy

- ◆ If the nozzle is partially choked, clean it.
- ◆ If the quality of the print does not improve even though the nozzle has been cleaned, wipe off the ink on the surface of the nozzle.

For details, see the "User's Guide" included with the printer.

* Please see your printer manual for information about printing problems, printer maintenance, and details related to printing.

Specifications

BOARD TYPE (Model name)		Standard (M-18S)	Wide (M-18W)	
Form	Installation method	Self-standing (T-shaped legs), or wall mounting		
	External dimensions (T-shaped legs*1)	W1480 × D675 × H1947*2 mm	W1980 × D675 × H1947*2 mm	
	Main unit weight	20 kg*3	25 kg*3	
	T-shaped legs weight	12.5 kg		
BOARD	Panel Size	H910 × W1300 mm	H910 × W1800 mm	
	Effective reading size	H900 × W1280 mm	H900 × W1780 mm	
	Number of Pages	2		
	Paging	Endless in one direction (Horizontal scrolling)		
	Drive method	Sheet movement		
	Reading method	CIS (Contact Image Sensor)		
	Reading illumination light source	RGB LED		
	Reading resolution	Main scanning direction (vertical sheet surface) 1.92 dots/mm (50 dpi or equivalent) Sub scanning direction (horizontal sheet surface) 1.92 dots/mm (50 dpi or equivalent)		
	Reading time	Black & white: approx. 15 s Color: approx. 15 s	Black & white: approx. 21 s Color: approx. 21 s	
Interface	Board	File format	JPEG format (or PDF format*4)	
		Screen size	Standard type: 2458 x 1728 dots (fixed) Wide type: 3418 x 1728 dots (fixed)	
	External memory	Type	USB Flash memory	
		Compatible FAT types	FAT 16, 32	
		Interface	USB1.1 or USB2.0 *5	
	Printing	Printing resolution	300 dpi or equivalent	
		No. print colors	16 or grayscale	
		Printer interface	Conforming to USB 2.0 standards	
Added functions	Clock	Used for the timestamp and for file dating properties (Includes backup battery for when there is a loss of power. Battery life: Approx. 00 hours)		
	PC connection	Images can be acquired and device settings made via USB (using a browser)		
Power supply	AC power adapter	Input : AC100–240V/50–60 Hz, Max 0.75 A Output : DC 12 V, 3.0 A		
	Power consumption	In standby: 3W, During operation: 12W (not including printer)		
Operating conditions	Temperature:	10–35°C		
	Humidity:	30–85% (No condensation)		
Miscellaneous	Ruled lines	50 mm cross-ruled squares		
	Miscellaneous	Dedicated markers (black, red, blue, and green)		
Operating environment	OS	Fully IBM PC/AT compatible computer equipped with standard USB port. XP (Home Edition /Professional Edition, Service Pack 3 or greater)/ Vista (32-bit version) / Windows 7(32-bit/64-bit) Or, Apple Macintosh computer with standard USB port Mac OS X 10.5 or greater		
	Web browser	Windows : Internet Explorer 8.0 or greater Macintosh : Safari 5 or greater * Enable JavaScript. * With Adobe Flash Player 10 installed		

Remarks

*1: The height is adjustable at 1747, 1847 and 1947 mm.

*2: The value indicated for “H” (height) is the maximum height.

*3: Not including the weight of the printer.

*4: North America Only.

*5: USB memory device not included. The memory capacity corresponds to 32GB or less.

• Please note that for quality improvement purposes, specifications and design are subject to change without prior notice.

Connections and Wiring Diagram

- The connections and wiring diagram below is included here for checking the connections.

[Copyboard and Printer Connections Diagram]

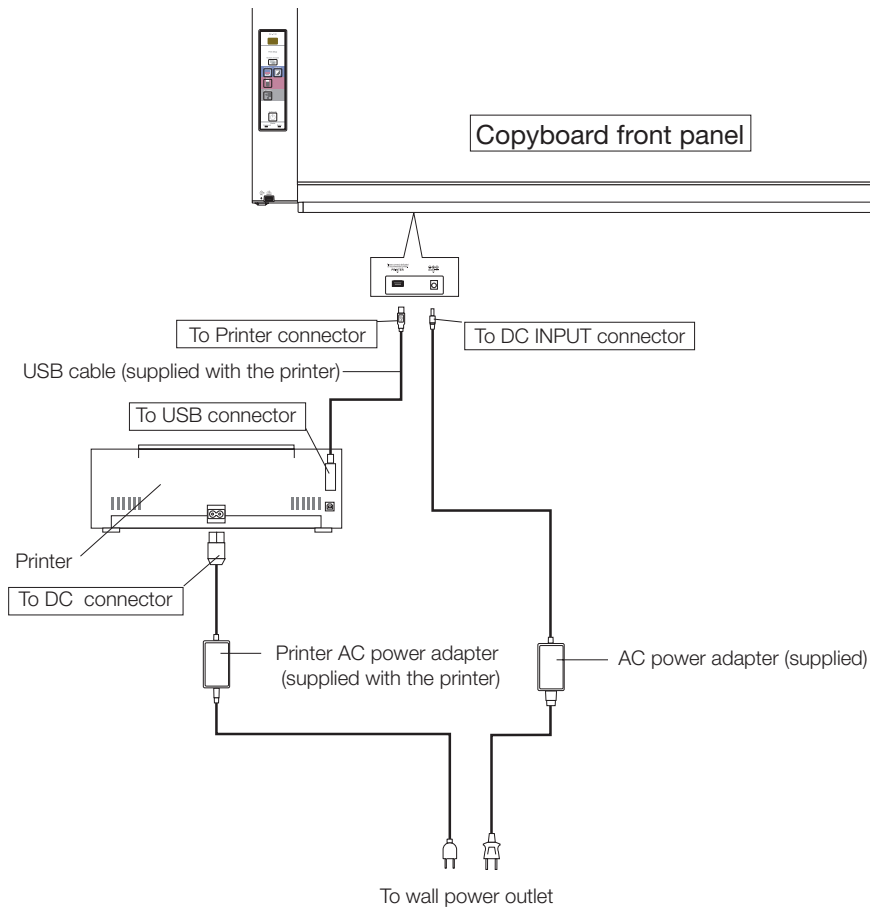

* Appearance of printer is for illustration purposes.

Note

The AC power adapters of accessories and printers that have been verified to be operation many differ from the ones shown on the connections diagram (they may be of the built-in or mounted-on type).

PLUS Corporation

ISO 14001 certification.

©2011, PLUS Corporation

26-4601-11B