



# Samsung Flip 2

Teamwork simplified

**SAMSUNG**

# Welcome to your best work life

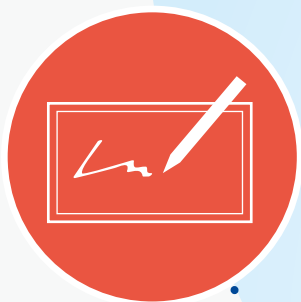

## Pen & paper annotation

- Pen Mode
- NEW** • Brush Mode
- Flexible Erasing
- Multi Writing up to 4
- InGlass Technology



## Intuitive usability

- Capture
- NEW** • Selection Tool
- NEW** • Merge to Roll
- NEW** • Annotation on
- Seamless Scroll
- Quick Finder



## SAMSUNG FLIP2



## Convenience

- NEW** • Web Browser
- Document Viewer
- Screen Saver
- Various form Options
- NEW** • Samsung Workspace

# What is Samsung Flip 2?

Samsung Flip is an intuitive and easy-to-use digital flipchart for any meeting environment, offering enhanced collaboration capabilities in an easy UI with a host of features, including brush mode, annotation on, merge to roll, and other collaboration tools. Available in two sizes, 55 and 65 inches, both models offer great collaborative features supported by unique designs. The 55-inch model offers increased workspace in front of the display, a hinge assembly structure and wheels for an efficient, moveable solution. The 65-inch model provides a larger screen which can be used as the main display in a meeting room, while the no gap wall mount removes any unnecessary space between the product and the wall. No matter the size, the Samsung Flip allows teams to work smarter, faster and better.

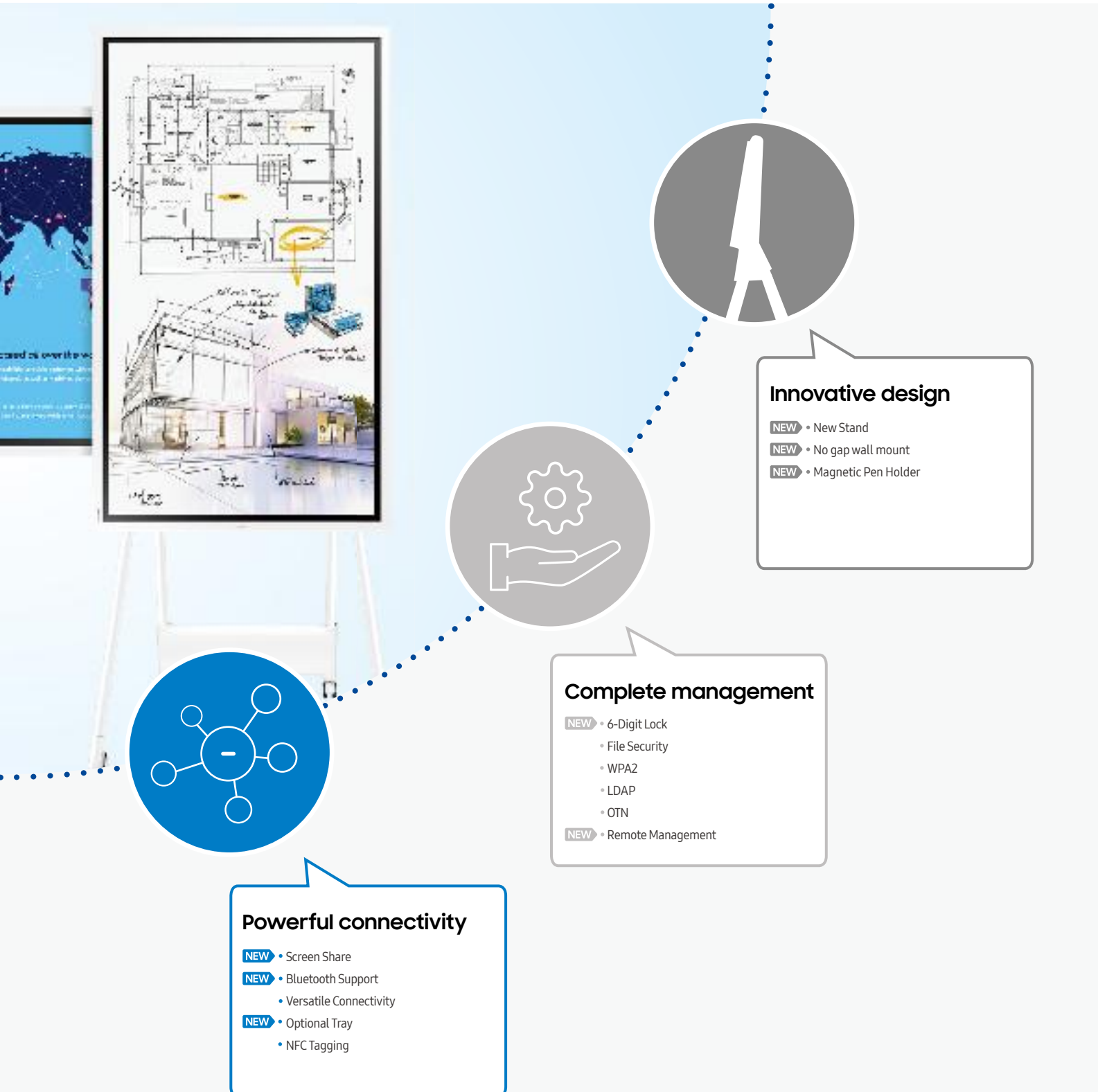

# Pen & paper annotation

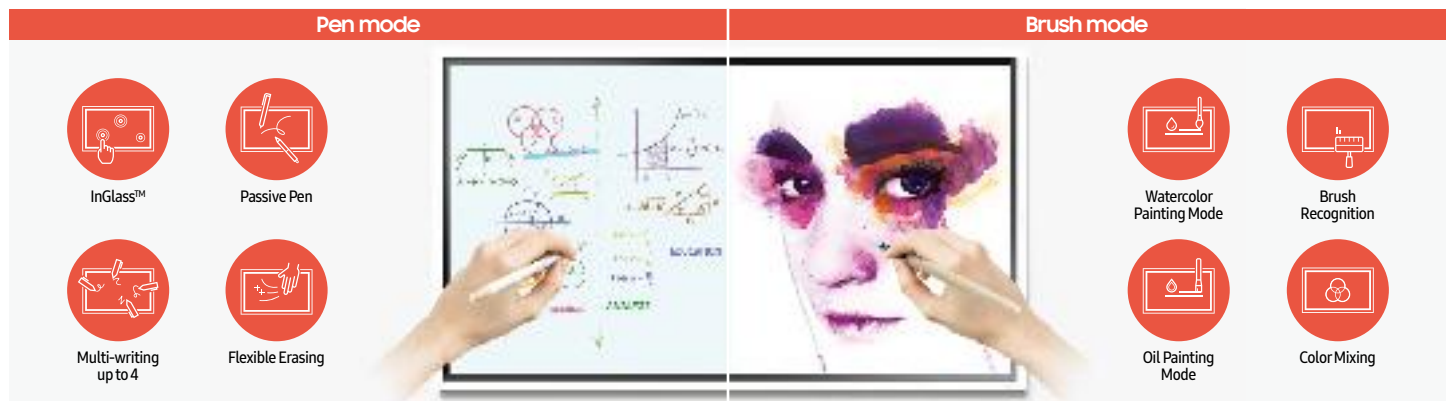

## Pen mode & Brush mode notation

### Draw, write & inspire new ideas

Samsung Flip provides smooth and familiar pen-to-paper-like writing in a variety of colors, styles and widths, while Brush Mode allows users to create art at the stroke of a brush in watercolor and oil painting modes. Up to 4 people can write simultaneously and erase drawings with a finger or palm swipe.

# Intuitive usability



## Selection tool & Merge to roll Flexible image editing

Bringing versatility to the board. With Samsung Flip, users can quickly and easily select, move, crop, capture, and edit any image. Each Image can also be merged to the roll with just one click of a button, allowing it to be edited or erased.



## Annotation on Write on any background

Samsung Flip allows users to write on any background source. By simply clicking the note layer button, users can enjoy smooth writing anytime, anywhere on any content displayed, without affecting any work behind the original layer.

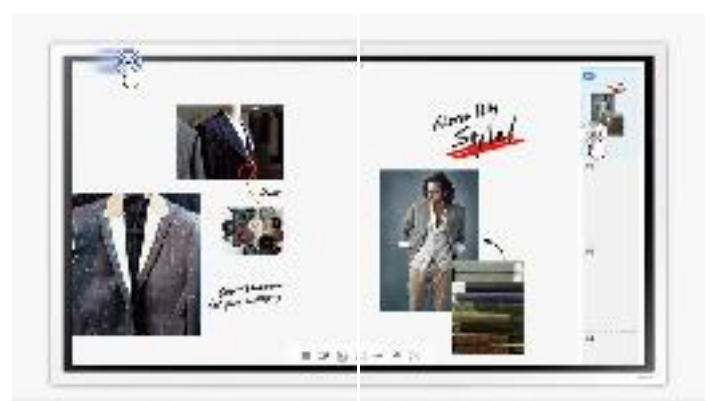

## Seamless scroll & Quick finder Easy content navigation

Samsung Flip has up to 20 pages of writing space per roll, allowing users to seamlessly scroll through pages. The Flip's intuitive, user-friendly menu simplifies navigation and saves time, while the quick finder feature allows users to preview content and make instant changes directly on the screen.

# Convenience



## Web browser Simple web surfing while annotating

Samsung Flip now supports web browsing and allows users to access the internet directly through the display, with no additional device needed. Once the browser is open, annotation is still available for users to draw around the browser too.



## Document viewer Direct document access

Samsung Flip gives users the capability to open Microsoft Word, Microsoft PowerPoint, Microsoft Excel and PDF files directly with a built-in document viewer, ensuring easy access regardless of the content source.



## Screen saver Custom screen saver to reinforce your brand

When the display is not in use, users can select a custom image to be shown on the Flip as a screensaver. This means the Samsung Flip can help to reinforce a brand, for example, by displaying a company logo, providing an efficient solution even when not in use.



## Various form options Suitable for all business needs

Samsung Flip can be used for a wide range of business applications, providing embedded versatile templates. You can use the Flip as a calendar, scheduler, note or checklist board, perfectly matching any business need, enabling users to utilize the display in the ways that are most useful for them.



## Samsung Workspace Comprehensive connectivity

The Flip features Samsung Workspace, which supports wireless cloud service access, Microsoft Office 365 access, and control of a PC without the need for a physical connection. Backed by Samsung's Knox security, this all ensures the Flip makes meeting spaces simpler, safer and more efficient.

# Powerful connectivity

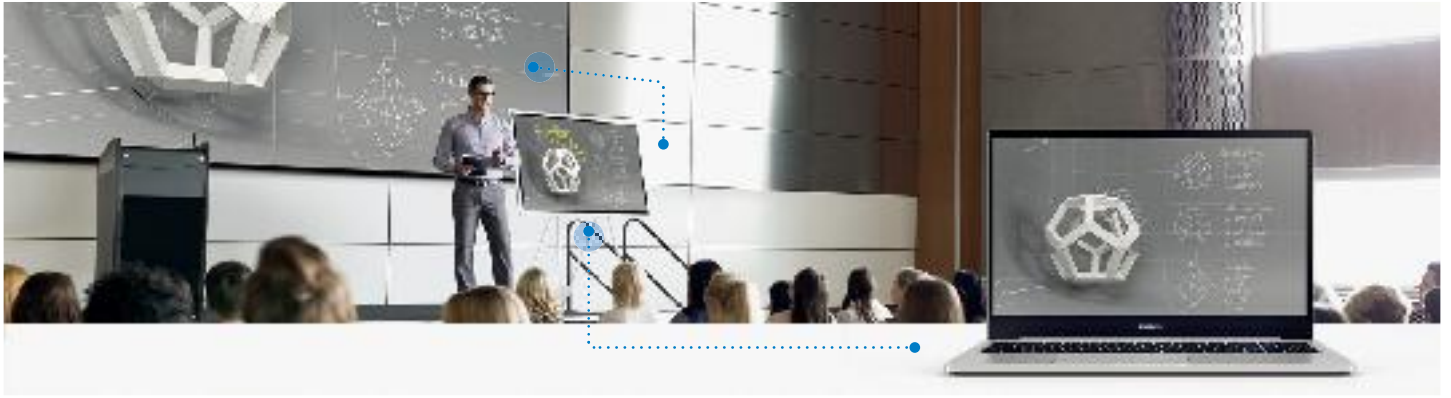

## Screen share

### Large audience sharing

Users can project content on the Flip to another large digital display in real time, using a Wi-Fi Direct or HDMI out connection. The Flip display can even be shared while connected to a personal device, ideal for large meeting environments, delivering information to bigger audiences.



## Bluetooth support

### Familiar and flexible devices

The Samsung Flip allows users to connect a bluetooth keyboard and mouse to the Flip, creating a more convenient and efficient meeting environment by enabling the use of familiar devices and tools for each user.

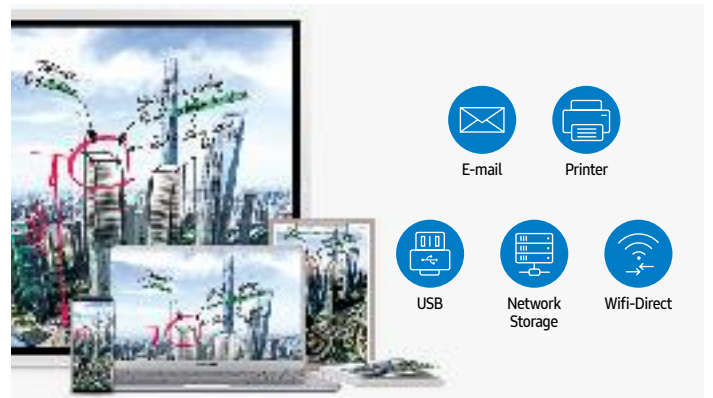

## Easy sharing

### Effortless meeting recaps

Following any meeting, users can distribute recaps to all attendees and colleagues, removing the time frustration traditionally associated with handwritten meeting notes. Important conversations and content are stored within the Flip in real-time, easily shareable across mobile and digital channels.



HDMI



USB



Screen Mirroring



WIN10

## Versatile connectivity

### Multiple connection options

Users are empowered by the Flip's versatile connection options. USB, HDMI, NFC and wireless connection capabilities enable optimum collaboration and provide interactive content visibility, notation and sharing. The Flip also offers an optional tray as a more powerful connectivity extension.

# Complete management



## 6-digit lock Safe, secure content protection

Samsung Flip ensures that confidential meeting information remains in the right hands. Using its reinforced, 6-digit lock system, each in-office team is able to safeguard sensitive content, lock the display and remove critical content from view.



## Remote management Comprehensive control options

Users can remotely control critical display settings of the Flip through Samsung's Remote Management solution. This provides the ability to power the display on and off, change the pin code, lock the network or USB port and adjust proxy server settings for enhanced convenience.

\*Samsung's Remote Management solution must be purchased separately.



**File Security**  
Set to delete files regularly



**LDAP (Lightweight Directory Access Protocol)**  
Connect to an enterprise user database



**WPA2 (802.1x based standard)**  
Secure wireless connectivity



**OTN (Over the Network)**  
Automatic firmware updates

## Advanced convenience and security Convenient, optimized management

Samsung Flip offers improved capabilities, including secure wireless connection, automatic firmware updates and LDAP synchronization when connected to network database for convenient, functional meetings.



## Enhanced new design for multiple environments

The new, slim stand for Flip 55-inch offers increased workspace in front of the display and an enhanced hinge assembly structure for increased flexibility and efficient installation. Wheels on the base of the model also enable the display to be easily moved around to any position. The no gap wall mount of the Flip 65-inch removes any unnecessary space between the product and the wall, creating a seamless solution that blends into any environment. The larger size of the 65-inch model also provides a display that can be used for larger meeting rooms. In addition to the new size options, both models have a convenient magnetic pen holder, meaning users do not have to worry about misplacing the pen and can get to work immediately once coming back to the display.

\*Some of the design features may vary according to different types of accessories and inches.



# Specifications

| Model            |                                 | WM55R  | WM65R  |  |
|------------------|---------------------------------|--|--|--|
| Panel            | Diagonal Size                   | 55"  | 65"  |  |
|                  | Type                            | 60Hz New Edge  | 60Hz New Edge  |  |
|                  | Resolution                      | 3,840 x 2,160 (Landscape)  | 3,840 x 2,160 (Landscape)  |  |
|                  | Brightness(Typ.)                | 350 (without glass), 220 (with glass)  | 350 (without glass), 220 (with glass)  |  |
|                  | Contrast Ratio(Typ.)            | 4000:1 (Typ.)(without glass)   | 4000:1 (Typ.)(without glass)   |  |
|                  | Viewing Angle(H/V)              | 178/178  | 178/178  |  |
|                  | Operation Hour                  | 16/7   | 16/7   |  |
| Sound            | Response Time(G-to-G)           | 8ms(Typ.)  | 8ms(Typ.)  |  |
|                  | Speaker Type                    | Built in Speaker (10W x 2)   | Built in Speaker (10W x 2)   |  |
| Connectivity     | INPUT                           | VIDEO<br>(Basic) HDMI 2, (With Tray) HDMI 3  | (Basic) HDMI 2, (With Tray) HDMI 3   |  |
|                  | OUTPUT                          | USB<br>(Basic) USB 1, (With Tray) USB 2, USB External (In/Out)1  | (Basic) USB 1, (With Tray) USB 2, USB External (In/Out)1   |  |
|                  | INTERNAL                        | Touch Out<br>(Basic) Touch Out 1 (USB Upstream Type), Audio Out 1<br>(With Tray) Touch Out 2, Audio Out 1, Screen Share(HDMI-Out)1 | (Basic) Touch Out 1 (USB Upstream Type), Audio Out 1<br>(With Tray) Touch Out 2, Audio Out 1, Screen Share(HDMI-Out)1                        |  |
|                  | EXTERNAL                        | SENSOR<br>(Basic) Acceleration sensor<br>(With Tray) Acceleration sensor, NFC  | (Basic) Acceleration sensor<br>(With Tray) Acceleration sensor, NFC  |  |
| Touch            | CONTROL                         | Touch Input, RS232C, RJ45 (Not for User Control)   | Touch Input, RS232C, RJ45 (Not for User Control)   |  |
|                  | Type                            | InGlass™   | InGlass™   |  |
|                  | # of Drawing                    | Multi writing up to 4  | Multi writing up to 4  |  |
|                  | Touch Pen Type                  | Passive Pen with magnet  | Passive Pen with magnet  |  |
| Power            | Object Recognition Range        | 2mm/ 4mm / 8mm / 50mm, 1024 Level on Brush Mode  | 2mm/ 4mm / 8mm / 50mm, 1024 Level on Brush Mode  |  |
|                  | Touch Response Time             | 6.7ms  | 6.7ms  |  |
|                  | Type                            | Internal   | Internal   |  |
|                  | Power Supply                    | AC 100~240V 50/60Hz  | AC 100~240V 50/60Hz  |  |
|                  | Power Consumption               | Max[W/h]   | 154  | 181.5  |
|                  |                                 | Typical[W/h]   | 80   | 100  |
|                  |                                 | Rating[W/h]  | 140  | 165  |
| Stand-by[W/h]    |                                 | 0.5  | 0.5  |  |
| BTU[W/h]         |                                 | 525.14   | 618.915  |  |
| Mechanical Spec  | Dimension (mm)                  | Set<br>1297.4(W) x 768.2(H) x 59.9(D)  | Set<br>1522.4(W) x 897.6(H) x 62.9(D)  |  |
|                  | Weight (kg)                     | Set<br>28.2  | Set<br>40.0  |  |
|                  | Color                           | Light Gray   | Light Gray   |  |
|                  | VESA Mount                      | 400 x 400  | 400 x 400  |  |
|                  | Protection Glass                | Yes  | Yes  |  |
|                  | Stand Type                      | Moving Stand, Wallmount  | No-Gap Wall Mount  |  |
|                  | Rotation                        | Available with Flip moving stand (STN-WM55R)<br>(Available with rotation support 3rd party accessory)                              | N/A with Flip No-Gap Wallmount (WMN-WM65R)<br>(Available with rotation support 3rd party accessory)  |  |
|                  | Power Cable Length              | 3m   | 3m   |  |
|                  | Accessory                       | Cover-Jack   | Cover-Jack   |  |
|                  | Operation                       | Operating Temperature  | 0°C - 40°C   | 0°C - 40°C   |
| Humidity         |                                 | 10~80%   | 10~80%   |  |
| Feature          | Key                             | Flip App   | Flip App   |  |
|                  | Special                         | H/W  | Super Clear Coating, Temperature Sensor, Pivot Display, Clock Battery(168hrs Clock Keeping), Built in Speaker(10W x 2), WiFi Module Embedded | Super Clear Coating, Temperature Sensor, Pivot Display, Clock Battery(168hrs Clock Keeping), Built in Speaker(10W x 2), WiFi Module Embedded |
|                  |                                 | S/W  | Flip S/W   | Flip S/W   |
|                  | Platform Processor              | Muse-M (Tizen 5.0)<br>CA72 Quad(1.7GHz)  | Muse-M (Tizen 5.0)<br>CA72 Quad(1.7GHz)  |  |
|                  | On-Chip Cache Memory            | L1 (I/D) : 32KB / 32KB, L2 (Unified) : 1MB   | L1 (I/D) : 32KB / 32KB, L2 (Unified) : 1MB   |  |
|                  | Clock Speed                     | 1.7GHz CPU Quad  | 1.7GHz CPU Quad  |  |
|                  | Main Memory Interface           | LPDDR4 1.6GHz 64bit 2.5GB  | LPDDR4 1.6GHz 64bit 2.5GB  |  |
|                  | Internal Player (Embedded H/W)  | Graphics<br>2D & 3D Graphics Engine - Up to 1920x1080. 32bpp - Supports OpenGL ES*   | Graphics<br>2D & 3D Graphics Engine - Up to 1920x1080. 32bpp - Supports OpenGL ES  |  |
|                  | Storage                         | 8GB(2.65GB Occupied by O/S, 5.35GB Available)  | 8GB(2.65GB Occupied by O/S, 5.35GB Available)  |  |
|                  | IO Ports                        | USB 2.0  | USB 2.0  |  |
| Operating System | Samsung Proprietary OS(VDLinux) | Samsung Proprietary OS(VDLinux)  |  |  |
| Accessories      | Included                        | Passive Pen(2), Power Cable, Touch Out Cable (USB upstream)  | Passive Pen(2), Power Cable, Touch Out Cable (USB upstream)  |  |
|                  | Optional                        | Stand  | STN-WM55R  | N/A  |
|                  |                                 | Wallmount  | WMN4277SE  | WMN-WM65R  |
|                  |                                 | Tray   | CY-TF65BRC   | CY-TF65BRC   |
| Specialty        | Flip UX                         | Flip UX  |  |  |

| Wallmount for WM55R |                | - WMN4277SE |                              |
|---------------------|----------------|-------------|------------------------------|
| Mechanical Spec     | Dimension (mm) | Set         | 465(W) x 442(H) x 24.5(D) mm |
|                     |                | Package     | 510(W) x 280(H) x 90(D) mm   |
|                     | Weight (kg)    | Set         | 5.5                          |
|                     |                | Package     | 6.8                          |
|                     | Color          |             | Black                        |
| VESA Mount          |                | 400 X 400   |                              |
| Rotation            |                | N/A         |                              |
| Accessories         | Included       |             | Installation Guide, Screws   |

| Wallmount for WM65R |                | - WMN-WM65R |   |
|---------------------|----------------|-------------|---|
| Mechanical Spec     | Dimension (mm) | Set         | 520(W) x 280.3(H) x 15.9(D)                       |
|                     |                | Package     | 594(W) x 337(H) x 75(D)                           |
|                     | Weight (kg)    | Set         | 1.75  |
|                     |                | Package     | 3.2   |
|                     | Color          |             | Light Gray  |
| VESA Mount          |                | 400 X 400   |   |
| Rotation            |                | N/A         |   |
| Accessories         | Included       |             | Installation Guide, Screws                        |
| Feature             | Special        | H/W         | No-Gap Spacing, Extra Bracket for strong fixation |

| Stand for WM55R |                | - STN-WM55R          |  |
|-----------------|----------------|----------------------|--|
| Mechanical Spec | Dimension (mm) | Set                  | 835(W) x 1631.1(H) x 850.6(D)                  |
|                 |                | Package              | 1650(W) x 860(H) x 208(D)                      |
|                 | Weight (kg)    | Set                  | 34.5   |
|                 |                | Package              | 41.5   |
|                 | Color          |                      | Light Gray                                     |
| VESA Mount      |                | 400 X 400            |  |
| Rotation        |                | Pivot Supports (90°) |  |
| Accessories     | Included       |                      | Installation Guide, Screws                     |
| Feature         | Special        | H/W                  | Slim Design, No Assembly Required Installation |

| Tray for Flip 2 |                          | - CY-TF65BRC |                                       |
|-----------------|--------------------------|--------------|---------------------------------------|
| Mechanical Spec | Dimension (mm)           | Set          | 269.8(W) x 111.3(H) x 56.9(D)         |
|                 |                          | Package      | 294(W) x 136(H) x 69(D)               |
|                 | Weight (kg)              | Set          | 0.5                                   |
| Connectivity    | Color                    | Package      | 0.7                                   |
|                 |                          |              | Light Gray                            |
|                 | Extra Connectivity Ports |              | USB 1                                 |
|                 |                          |              | USB External (In/Out)1                |
|                 |                          |              | Touch Out 1                           |
| Accessories     | Included                 |              | HDMI-In 1                             |
|                 |                          |              | HDMI-Out(Screen Share) 1              |
| Feature         | Special                  | H/W          | NFC 1                                 |
|                 |                          |              | Installation Guide, Screws            |
|                 |                          |              | Easy install with dock connector      |
|                 |                          |              | Front facing connector for BYOD usage |

※ Specifications on the table are flexible and subject to change under certain circumstances.

# Installation guide

## Quick setup guide - Stand for WM55R

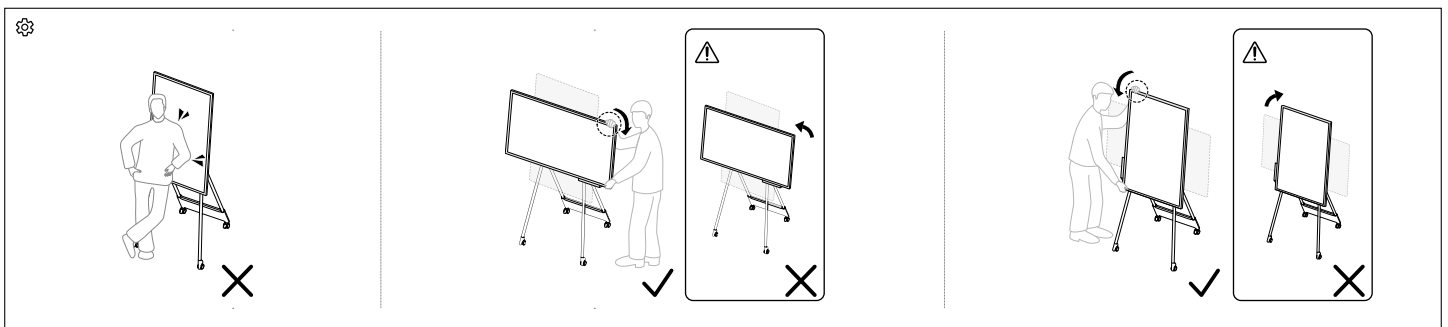
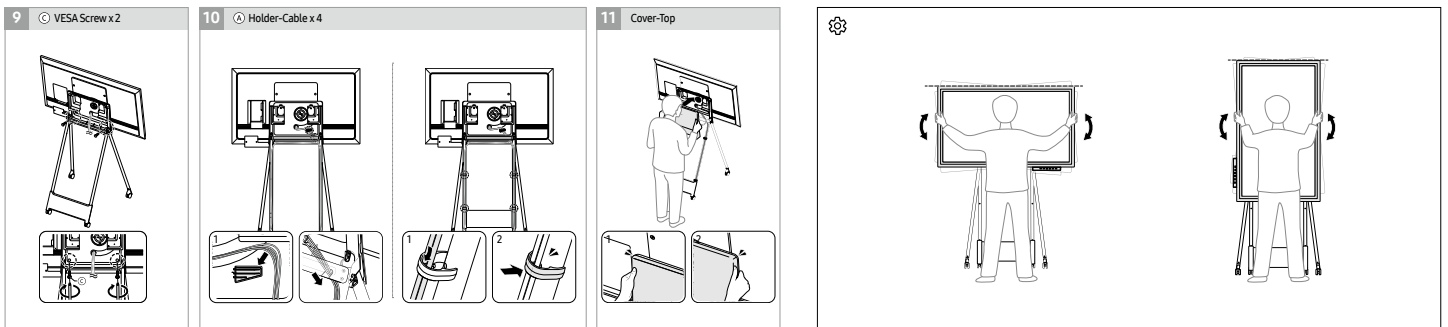
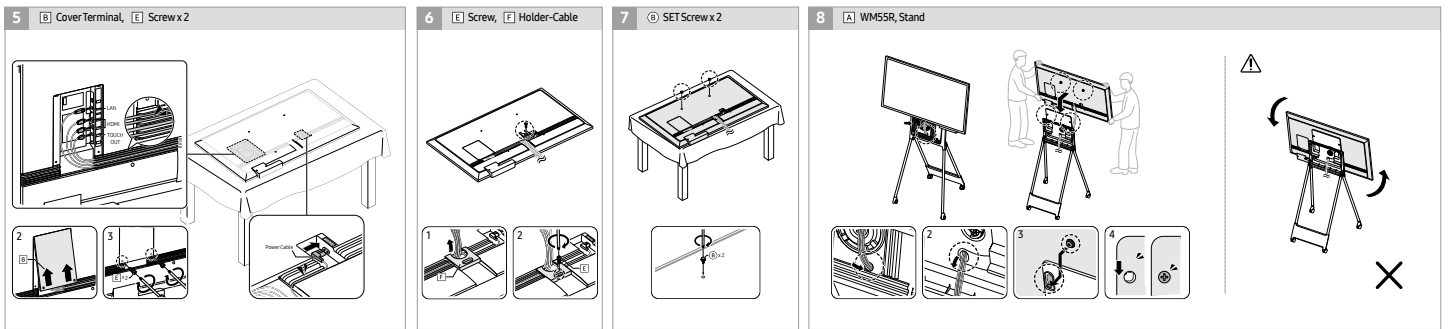
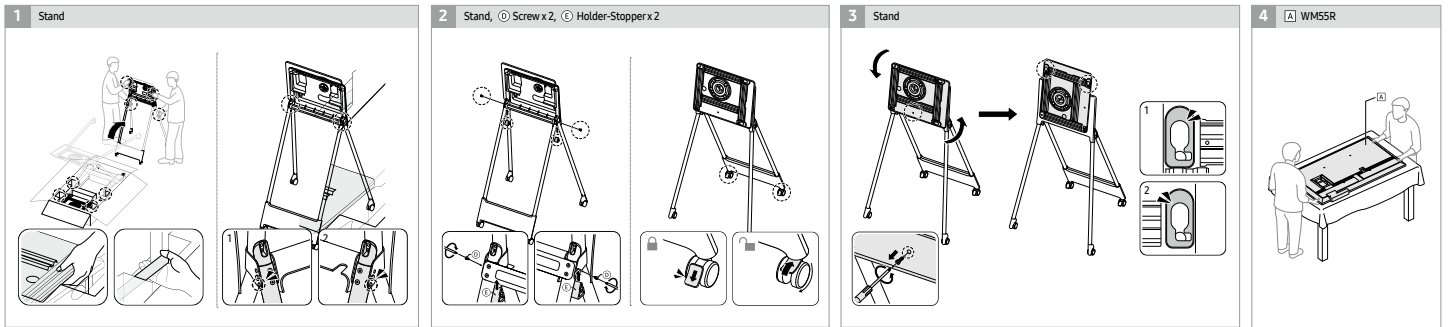
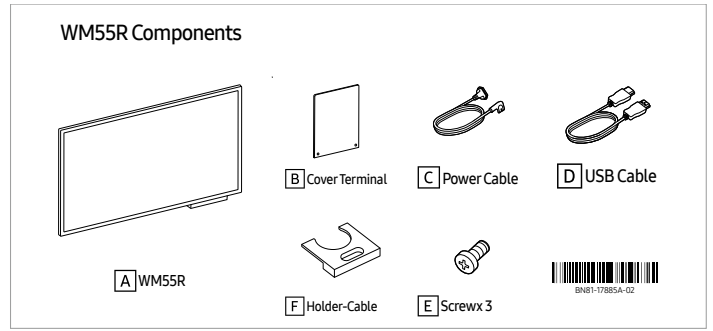
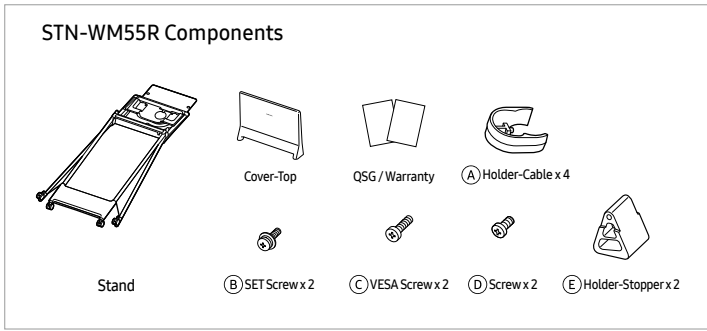

# Quick setup guide - Wallmount for WM65R

### WMN-WM65R Components

- 1 x 4 (M4 x 1.5)
- 1 x 8 (M4 x 1.5)
- x 6
- x 6
- x 6
- x 4

### WM65R Components

- WM65R
- Cover Terminal
- Power Cable
- Touch Cable
- Screw x 3
- Cover Cable

- 1
- 2
- 3
- 4
- 5
- 6
- 7
- 8
- 9
- 10
- 11
- 12
- 13
- 14

## Technical drawing

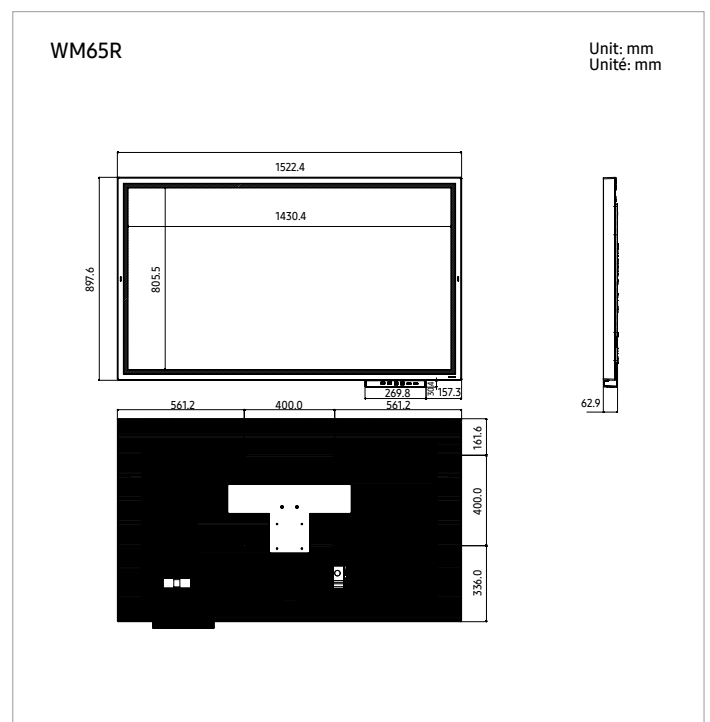
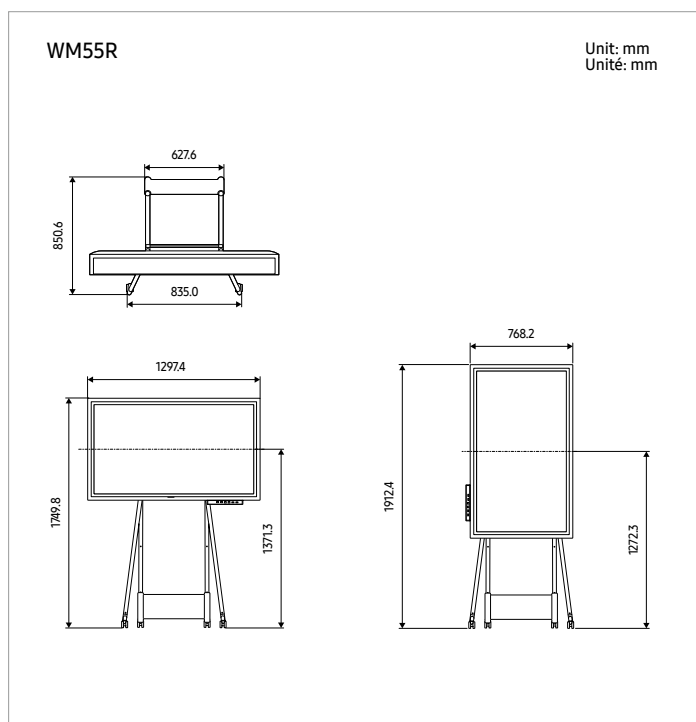

## **About Samsung Electronics Co., Ltd.**

Samsung Electronics Co., Ltd. inspires the world and shapes the future with transformative ideas and technologies. The company is redefining the worlds of TVs, smartphones, wearable devices, tablets, cameras, digital appliances, medical equipment, network systems, and semiconductor and LED solutions. For the latest news, please visit the Samsung Newsroom at [news.samsung.com](https://news.samsung.com).

## **Samsung Flip 2**

For more information about Samsung Flip 2, visit [www.samsung.com/business](https://www.samsung.com/business) or [www.samsung.com/displaysolutions](https://www.samsung.com/displaysolutions)

Copyright © 2019 Samsung Electronics Co. Ltd. All rights reserved. Samsung is a registered trademark of Samsung Electronics Co. Ltd. Specifications and designs are subject to change without notice. Non-metric weights and measurements are approximate. All data were deemed correct at time of creation. Samsung is not liable for errors or omissions. All brand, product, service names and logos are trademarks and/or registered trademarks of their respective owners and are hereby recognized and acknowledged.

Samsung Electronics Co., Ltd.  
416, Maetan 3-dong, Yeongtong-gu, Suwon-si, Gyeonggi-do 443-772, Korea

2019-09