



CinemaSnap



CinemaSnap

Easy to install and never requires surface re-tensioning!

SIZES 72" - 225"

Setting the benchmark for perfect lay flat and ease of installation, this fixed screen is designed to complement modern home theatre design, using a dedicated wall space.



Market Segments:



Home Entertainment



Government



Sports Venues

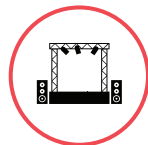

Staging & Production



Galleries



Theatre

Benefits include:

- Perfect lay flat
- Easy to install
- Contemporary design
- No moving parts
- Fire-rated surface



Wall bracket as supplied.
Wall fixings supplied by other.

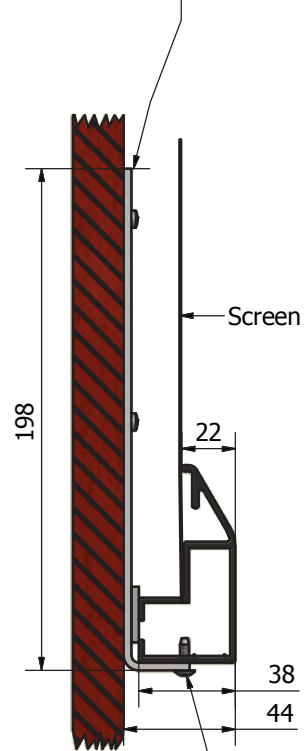

Screen Brackets
are attached by
2 self drilling screws.



Full technical drawings and installation instructions can be found on our website
Manufacturing tolerance +/- 3mm. All dimensions are in (mm). If installed in ceiling always allow for removal for servicing.

The Concept, Design and Details in this drawing are the property of Screen Technics with whom the copyright resides. They may not be reproduced without written permission of Screen Technics.

Date
01/10/2019

Rev
05

Product Features

DESCRIPTION:

Fixed Frame Screen - ready to assemble - best possible lay-flat qualities

SURFACE:

Easy snap on screen surface - Unity White Black Backed PVC - Gain 1.0

FRAME:

Black Powdercoat Finish for Increased Contrast and Overscan Protection

BORDERS:

As per frame system - 80mm wide

BRACKETS:

MultiTech Wall Brackets

SIZES:

72" Diagonal up to 225" Diagonal Custom Sizes & Formats available upon request

OPTIONS:

Flocke Frame Optional

ITEM NO	INCH DIAGONAL	IMAGE SIZE mm	FORMAT	WEIGHT kg	ITEM NO	INCH DIAGONAL	IMAGE SIZE mm	FORMAT	WEIGHT kg
1207219	72	1100 x 1465	4:3	16	1213029	130	1615 x 2880	16:9	25
1208419	84	1280 x 1705	4:3	17	1213529	135	1680 x 2990	16:9	26
1209619	96	1460 x 1950	4:3	18	1214029	140	1740 x 3100	16:9	27
1210019	100	1525 x 2035	4:3	19	1218029	180	2240 x 3985	16:9	34
1211019	110	1676 x 2235	4:3	21	1220029	200	2490 x 4425	16:9	38
1211519	115	1755 x 2340	4:3	22	1222529	225	2800 x 4980	16:9	43
1212019	120	1830 x 2440	4:3	23	1207269	72	970 x 1550	16:10	13
1213019	130	1980 x 2640	4:3	26	1208469	84	1130 x 1810	16:10	16
1215019	150	2285 x 3050	4:3	30	1209269	92	1240 x 1980	16:10	17
1216019	160	2440 x 3250	4:3	32	1209669	96	1295 x 2070	16:10	18
1217019	170	2590 x 3455	4:3	33	1210069	100	1345 x 2155	16:10	19
1218019	180	2745 x 3660	4:3	35	1211069	110	1480 x 2370	16:10	21
1220019	200	3050 x 4065	4:3	39	1212069	120	1615 x 2585	16:10	23
1222519	225	3430 x 4570	4:3	44	1213069	130	1750 x 2880	16:10	24
1207229	72	895 x 1595	16:9	13	1214069	140	1885 x 3015	16:10	27
1208429	84	1045 x 1860	16:9	16	1215069	150	2020 x 3230	16:10	29
1209229	92	1145 x 2035	16:9	17	1216069	160	2155 x 3450	16:10	32
1209629	96	1195 x 2125	16:9	18	1217069	170	2290 x 3665	16:10	33
1210029	100	1245 x 2215	16:9	19	1218069	180	2425 x 3880	16:10	34
1211029	110	1370 x 2435	16:9	21	1220069	200	2690 x 4310	16:10	38
1211529	115	1430 x 2545	16:9	22	1222569	225	3030 x 4850	16:10	43
1212529	125	1555 x 2770	16:9	24					

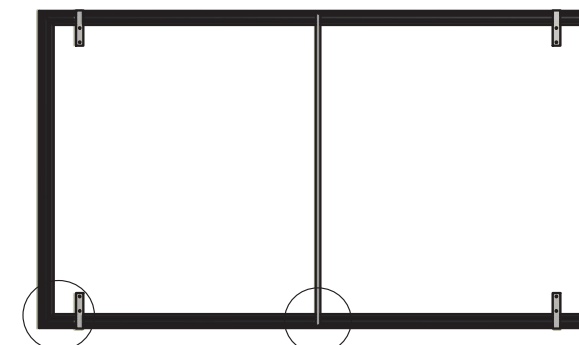

B

C

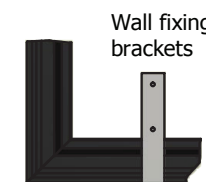

B (1:8)

Vertical spreader bar for all frames wider than 2600mm.



C (1:8)

ARCHITECTS SPECIFICATION

The projection screen shall be an Australian made Screen Technics CinemaSnap MW model 12_____with Unity White Black Backed PVC surface and shall be located where indicated on the plans. Installation shall be done in accordance with the manufacturer's instructions



AUSTRALIA

22-24 Suttor Road

Moss Vale NSW 2577

+61 2 4869 2100

screeentechnics.com.au • info@screeentechnics.com.au

NEW ZEALAND

44 Mahana Road

Te Rapa, Hamilton

+0800 022 821

Full technical drawings and installation instructions can be found on our website
Manufacturing tolerance +/- 3mm. All dimensions are in (mm). If installed in ceiling always allow for removal for servicing.

Product Features

DESCRIPTION:

Fixed Frame Screen - ready to assemble - best possible lay-flat qualities

SURFACE:

Easy snap on screen surface - Matrix White Grey Backed PVC - Gain 1.1

FRAME:

Black Flock Finish for Increased Contrast and Overscan Protection

BORDERS:

As per frame system - 80mm wide

BRACKETS:

MultiTech Wall Brackets

SIZES:

72" Diagonal up to 180" Diagonal Custom Sizes & Formats available upon request

ITEM NO	INCH DIAGONAL	IMAGE SIZE mm	FORMAT	WEIGHT kg	ITEM NO	INCH DIAGONAL	IMAGE SIZE mm	FORMAT	WEIGHT kg
1207216	72	1100 x 1465	4:3	16	1209266	92	1240 x 1980	16:10	17
1208616	84	1280 x 1705	4:3	17	1209666	96	1295 x 2070	16:10	18
1209616	96	1460 x 1950	4:3	18	1210066	100	1345 x 2155	16:10	19
1210016	100	1525 x 2035	4:3	19	1211066	110	1480 x 2370	16:10	21
1211516	115	1755 x 2340	4:3	21	1212066	120	1615 x 2585	16:10	23
1212016	120	1830 x 2440	4:3	23	1213066	130	1750 x 2880	16:10	24
1213016	130	1980 x 2640	4:3	26	1214066	140	1885 x 3015	16:10	27
1207226	72	895 x 1595	16:9	13	1215066	150	2020 x 3230	16:10	29
1208426	84	1045 x 1860	16:9	16	1208446	84	835 x 1965	2.35:1	18
1209226	92	1145 x 2035	16:9	17	1209246	92	915 x 2155	2.35:1	19
1209626	96	1195 x 2125	16:9	18	1209646	96	955 x 2245	2.35:1	20
1210026	100	1245 x 2215	16:9	19	1210046	100	995 x 2340	2.35:1	22
1211026	110	1370 x 2435	16:9	21	1211046	110	1095 x 2575	2.35:1	23
1211526	115	1430 x 2545	16:9	22	1212046	120	1195 x 2810	2.35:1	25
1212026	120	1495 x 2655	16:9	23	1213046	130	1295 x 3045	2.35:1	26
1212526	125	1555 x 2770	16:9	24	1214046	140	1395 x 3280	2.35:1	28
1213026	130	1615 x 2880	16:9	25	1215046	150	1495 x 3515	2.35:1	30
1213526	135	1680 x 2990	16:9	26	1216046	160	1595 x 3750	2.35:1	32
1214026	140	1740 x 3100	16:9	27	1217046	170	1695 x 3980	2.35:1	33
1215026	150	1865 x 3320	16:9	30	1218046	180	1795 x 4215	2.35:1	34
1207266	72	970 x 1550	16:10	13					
1208466	84	1130 x 1810	16:10	16					

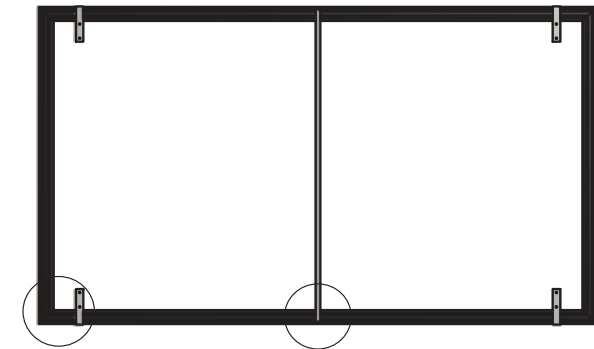

B

C

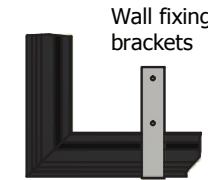

B (1:8)

Vertical spreader bar for all frames wider than 2600mm.



C (1:8)

ARCHITECTS SPECIFICATION

The projection screen shall be an Australian made Screen Technics CinemaSnap MX model 12_____with Matrix White Grey Backed PVC surface and shall be located where indicated on the plans. Installation shall be done in accordance with the manufacturer's instructions

Product Features

DESCRIPTION:

Fixed Frame Screen - ready to assemble - best possible lay-flat qualities

FRAME:

Black Powdercoat Finish for Increased Contrast and Overscan Protection

BRACKETS:

MultiTech Wall Brackets

OPTIONS:

Flocke Frame Optional

SURFACE:

Easy snap on screen surface - Hi Contrast Grey Black Backed - Gain 0.8

SIZES:

72" Diagonal up to 225" Diagonal Custom Sizes & Formats available upon request

BORDERS:

As per frame system - 80mm wide

ITEM NO	INCH DIAGONAL	IMAGE SIZE mm	FORMAT	WEIGHT kg	ITEM NO	INCH DIAGONAL	IMAGE SIZE mm	FORMAT	WEIGHT kg
1207218	72	1100 x 1465	4:3	16	1213528	135	1680 x 2990	16:9	26
1208418	84	1280 x 1705	4:3	17	1214028	140	1740 x 3100	16:9	27
1209618	96	1460 x 1950	4:3	18	1215028	150	1865 x 3320	16:9	29
1210018	100	1525 x 2035	4:3	19	1216028	160	1995 x 3545	16:9	32
1211018	110	1676 x 2235	4:3	21	1217068	170	2115 x 3765	16:9	33
1211518	115	1755 x 2340	4:3	22	1218068	180	2240 x 3985	16:9	34
1212018	120	1830 x 2440	4:3	23	1220068	200	2490 x 4425	16:9	38
1213018	130	1980 x 2640	4:3	26	1222568	225	2800 x 4980	16:9	43
1214018	140	2135 x 2845	4:3	28	1207268	72	970 x 1550	16:10	13
1215018	150	2285 x 3050	4:3	30	1208468	84	1130 x 1810	16:10	16
1216018	160	2440 x 3250	4:3	31	1209268	92	1240 x 1980	16:10	17
1217018	170	2590 x 3455	4:3	33	1209668	96	1295 x 2070	16:10	18
1218018	180	2745 x 3660	4:3	35	1210068	100	1345 x 2155	16:10	19
1220018	200	3050 x 4065	4:3	39	1211068	110	1480 x 2370	16:10	21
1207228	72	895 x 1595	16:9	13	1212068	120	1615 x 2585	16:10	23
1208428	84	1045 x 1860	16:9	16	1213068	130	1750 x 2880	16:10	24
1209228	92	1145 x 2035	16:9	17	1214068	140	1885 x 3015	16:10	27
1209628	96	1195 x 2125	16:9	18	1215068	150	2020 x 3230	16:10	29
1210028	100	1245 x 2215	16:9	19	1216068	160	2155 x 3450	16:10	32
1211028	110	1370 x 2435	16:9	20	1217068	170	2290 x 3665	16:10	33
1211528	115	1430 x 2545	16:9	22	1218068	180	2425 x 3880	16:10	34
1212028	120	1495 x 2655	16:9	23	1220068	200	2690 x 4310	16:10	38
1212528	125	1555 x 2770	16:9	24	1222568	225	3030 x 4850	16:10	43
1213028	130	1615 x 2880	16:9	25					

Full technical drawings and installation instructions can be found on our website
 Manufacturing tolerance +/- 3mm. All dimensions are in (mm). If installed in ceiling always allow for removal for servicing.

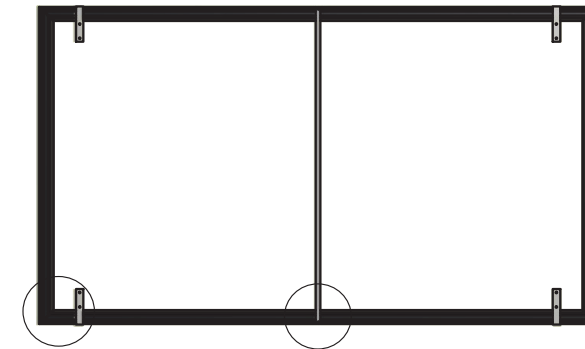

B

C

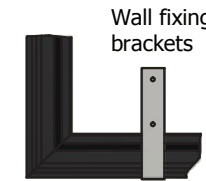

Wall fixing brackets

Vertical spreader bar for all frames wider than 2600mm.



B (1:8)

C (1:8)

ARCHITECTS SPECIFICATION

The projection screen shall be an Australian made Screen Technics CinemaSnap HCG model 12_____with Hi Contrast Grey surface and shall be located where indicated on the plans. Installation shall be done in accordance with the manufacturer's instructions

Product Features

DESCRIPTION:

Fixed Frame Screen - ready to assemble - best possible lay-flat qualities

SURFACE:

Easy snap on screen surface - Micro-Perforated - Gain 0.95

FRAME:

Flock Finish for Increased Contrast and Overscan Protection

BORDERS:

As per frame system - 80mm wide

BRACKETS:

MultiTech Wall Brackets

SIZES:

72" Diagonal up to 180" Diagonal Custom Sizes & Formats available upon request

OPTIONS:

Matt Black Powder Coat Frame (Flocke Standard)

ITEM NO	INCH DIAGONAL	IMAGE SIZE mm	FORMAT	WEIGHT kg	ITEM NO	INCH DIAGONAL	IMAGE SIZE mm	FORMAT	WEIGHT kg
1207213	72	1100 x 1465	4:3	16	1208463	84	1130 x 1810	16:10	16
1208413	84	1280 x 1705	4:3	17	1209263	92	1240 x 1980	16:10	17
1209613	96	1460 x 1950	4:3	18	1209663	96	1295 x 2070	16:10	18
1210013	100	1525 x 2035	4:3	19	1210063	100	1345 x 2155	16:10	19
1211013	110	1676 x 2235	4:3	21	1211063	110	1480 x 2370	16:10	21
1211513	115	1755 x 2340	4:3	22	1212063	120	1615 x 2585	16:10	23
1212013	120	1830 x 2440	4:3	23	1213063	130	1750 x 2880	16:10	24
1213013	130	1980 x 2640	4:3	26	1214063	140	1885 x 3015	16:10	27
1215013	150	2285 x 3050	4:3	30	1215063	150	2020 x 3230	16:10	29
1207223	72	895 x 1595	16:9	13	1208443	84	835 x 1965	2.35:1	18
1208423	84	1045 x 1860	16:9	16	1209243	92	915 x 2155	2.35:1	19
1209223	92	1145 x 2035	16:9	17	1209643	96	955 x 2245	2.35:1	20
1209623	96	1195 x 2125	16:9	18	1210043	100	995 x 2340	2.35:1	22
1210023	100	1245 x 2215	16:9	19	1211043	110	1095 x 2575	2.35:1	23
1211023	110	1370 x 2435	16:9	20	1212043	120	1195 x 2810	2.35:1	25
1211523	115	1430 x 2545	16:9	22	1213043	130	1295 x 3045	2.35:1	26
1212523	125	1555 x 2770	16:9	24	1214043	140	1395 x 3280	2.35:1	28
1213023	130	1615 x 2880	16:9	25	1215043	150	1495 x 3515	2.35:1	30
1213523	135	1680 x 2990	16:9	26	1216043	160	1595 x 3750	2.35:1	32
1214023	140	1740 x 3100	16:9	27	1217043	170	1695 x 3980	2.35:1	33
1218023	180	2240 x 3985	16:9	34	1218043	180	1795 x 4215	2.35:1	34
1207263	72	970 x 1550	16:10	13					

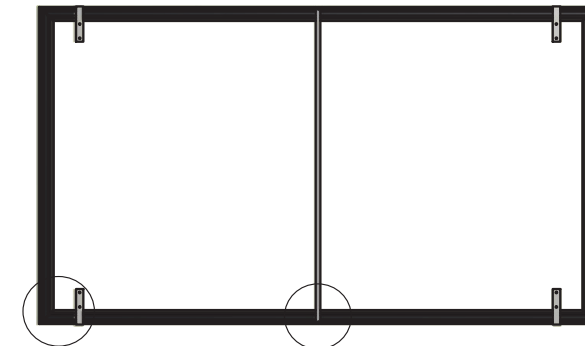

B

C

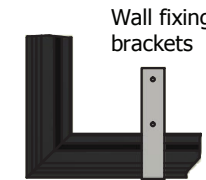

B (1:8)

Vertical spreader bar for all frames wider than 2600mm.



C (1:8)

ARCHITECTS SPECIFICATION

The projection screen shall be an Australian made Screen Technics CinemaSnap MP model 12_____with Microperforated PVC surface and shall be located where indicated on the plans. Installation shall be done in accordance with the manufacturer's instructions

Product Features

DESCRIPTION:

Fixed Frame Screen - ready to assemble - best possible lay-flat qualities

SURFACE:

Easy snap on screen surface - Rear Projection

FRAME:

Black Powdercoat Finish for Increased Contrast and Overscan Protection

BORDERS:

As per frame system - 80mm wide

BRACKETS:

MultiTech Wall Brackets

SIZES:

72" Diagonal up to 180" Diagonal Custom Sizes & Formats available upon request

OPTIONS:

Flocke Frame Optional

ITEM NO	INCH DIAGONAL	IMAGE SIZE mm	FORMAT	WEIGHT kg	ITEM NO	INCH DIAGONAL	IMAGE SIZE mm	FORMAT	WEIGHT kg
1207215	72	1100 x 1465	4:3	16	1212525	125	1555 x 2770	16:9	24
1208415	84	1280 x 1705	4:3	17	1213025	130	1615 x 2880	16:9	25
1209615	96	1460 x 1950	4:3	18	1213525	135	1680 x 2990	16:9	26
1210015	100	1525 x 2035	4:3	19	1215025	140	1740 x 3100	16:9	30
1211515	115	1755 x 2340	4:3	22	1208465	84	1130 x 1810	16:10	16
1212015	120	1830 x 2440	4:3	23	1209265	92	1240 x 1980	16:10	17
1213015	130	1980 x 2640	4:3	26	1209665	96	1295 x 2070	16:10	18
1215015	150	2285 x 3050	4:3	30	1210065	100	1345 x 2155	16:10	19
1218015	180	2745 x 3660	4:3	35	1211065	110	1480 x 2370	16:10	21
1208425	84	1045 x 1860	16:9	16	1212065	120	1615 x 2585	16:10	23
1209225	92	1145 x 2035	16:9	17	1213065	130	1750 x 2880	16:10	24
1209625	96	1195 x 2125	16:9	18	1214065	140	1885 x 3015	16:10	27
1210025	100	1245 x 2215	16:9	19	1215065	150	2020 x 3230	16:10	29
1211525	115	1430 x 2545	16:9	22	1218065	180	2425 x 3880	16:10	34
1212025	120	1495 x 2644	16:9	23					



B



B (1:8)

ARCHITECTS SPECIFICATION

The projection screen shall be an Australian made Screen Technics CinemaSnap RP model 12_____with Rear Projection PVC surface and shall be located where indicated on the plans. Installation shall be done in accordance with the manufacturer's instructions

Product Features

DESCRIPTION:

Fixed Frame Screen - ready to assemble - best possible lay-flat qualities

SURFACE:

Acoustic woven surface

FRAME:

Aluminum construction with black flocked frame for projector over-scan reduction

BORDERS:

As per frame system - 80mm wide

BRACKETS:

MultiTech Wall Brackets

SIZES:

84" to 180" Diagonal. Custom sizes and formats available upon request.

OPTIONS:

Also available on request in 2.37:1, 2.39:1 and 2.40:1

The new Matrix Woven acoustic surface is now available and ready for sale. Designed, built and finished on site at Moss Vale this surface provides the best possible audio solution when speakers are placed behind the projection screen. This surface is wide enough that it does not require any welds and provides the ultimate home theatre experience. Sizes above 110" normally require a center brace however, the Matrix Woven CinemaSnaps comes with 2 braces allowing for speakers to be placed at the back of the screen in the center, left and right. Our novel spring design tensions the Matrix Woven surface allowing for easy install and never requires surface re-tensioning!

MODEL NUMBER	SIZE	FORMAT	IMAGE SIZE (mm)		WEIGHT (kg)	MODEL NUMBER	SIZE	FORMAT	IMAGE SIZE (mm)		WEIGHT (kg)
			H	W					H	W	
16:9 FORMAT						2.35:1 FORMAT					
1208427	84"	16:9	1045	1860	16	1208447	84"	2.35:1	835	1965	18
1209227	92"	16:9	1145	2035	17	1209247	92"	2.35:1	915	2155	19
1209627	96"	16:9	1195	2125	18	1209647	96"	2.35:1	955	2245	20
1210027	100"	16:9	1245	2215	19	1210047	100"	2.35:1	995	2340	22
1211027	110"	16:9	1370	2435	21	1211047	110"	2.35:1	1095	2575	23
1212027	120"	16:9	1495	2655	23	1212047	120"	2.35:1	1195	2810	25
1213027	130"	16:9	1615	2880	25	1213047	130"	2.35:1	1295	3045	26
1214027	140"	16:9	1740	3100	27	1214047	140"	2.35:1	1395	3280	28
1215027	150"	16:9	1865	3320	30	1215047	150"	2.35:1	1495	3515	30
1216027	160"	16:9	1995	3545	32	1216047	160"	2.35:1	1595	3750	32
1217027	170"	16:9	2115	3765	33	1217047	170"	2.35:1	1695	3980	33
1218027	180"	16:9	2240	3985	34	1218047	180"	2.35:1	1795	4215	34
1219027	190"	16:9	2365	4205	36	1219047	190"	2.35:1	1895	4455	35
1220027	200"	16:9	2490	4425	38	1220047	200"	2.35:1	1995	4690	36
1221027	210"	16:9	2615	4650	40	1221047	210"	2.35:1	2095	4915	38

Full technical drawings and installation instructions can be found on our website
 Manufacturing tolerance +/- 3mm. All dimensions are in (mm). If installed in ceiling always allow for removal for servicing.

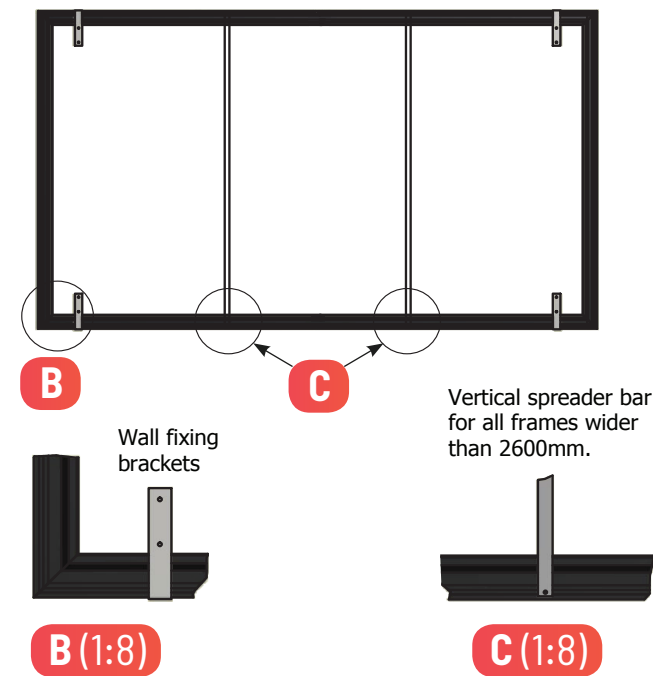

ARCHITECTS SPECIFICATION

The projection screen shall be an Australian made Screen Technics CinemaSnap MP model 12_____with Matrix Woven surface and shall be located where indicated on the plans. Installation shall be done in accordance with the manufacturer's instructions